

Safety

Correct rain cover usage

- Use the speaker in upright (shown left) or kickback (shown right) orientations only.

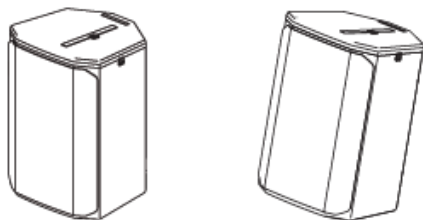

- Do not use the speaker in monitor mode in damp or wet conditions.

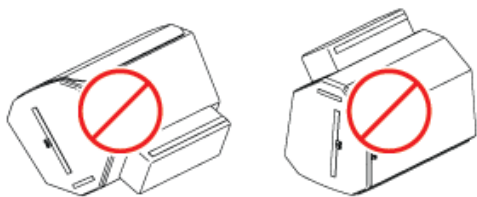

- Route the cables out of the bottom of the amp pocket. Make sure that the zippers are tight around the cables.

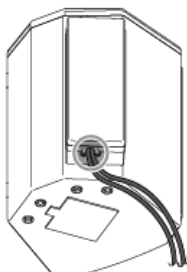

- Do not route the cables out of the sides of the amp pocket. Do not leave the amp pocket unzipped.

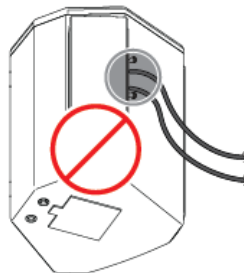

- Do not submerge the speaker in water or spray with a water hose.

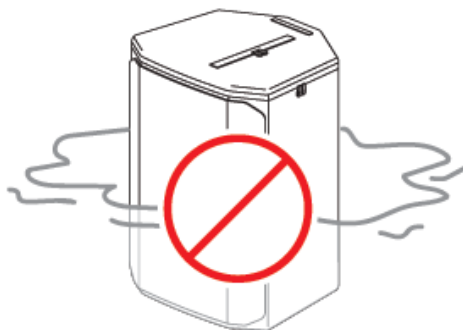

Cleaning and drying instructions

- Clean with a damp cloth.
- Air-dry only.
- Do not machine wash.
- Do not tumble dry.

Drain holes

The EVERSE rain cover was designed with four drain holes. The goal is to drain any water that may penetrate the inside of the rain cover.

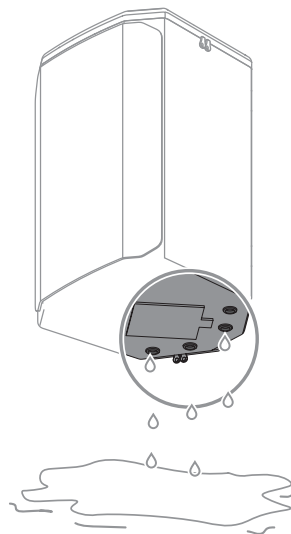

IP rating

The EVERSE loudspeaker with the rain cover installed is rated for IP44, but only in upright and kickback orientations, and only when used properly as defined in the included Quick user guide.

Some water may pool at the bottom of the rain cover when exposed for an extended period of time. Remove the speaker from the bag to allow both to dry properly. When using the rain cover, the weatherized input cover is optional to achieve the IP44 rating.

Weatherization

When the rain cover is installed, the EVERSE loudspeaker is designed to be weather resistant to IP44 standards, but not waterproof. The weather resistance may be reduced by damage, repair, improper disassembly, and regular wear and tear. Always inspect the EVERSE loudspeaker and accessories before and after every use. Allow the loudspeaker and components to dry before storage or between uses.

The EVERSE loudspeaker with rain cover installed is intended only for temporary use in wet or damp environments. The loudspeaker is not intended to be exposed continuously to moisture over long periods of time. Do not expose to salt water or spray, do not expose to chlorine or use in high chlorine environments.

Using the rain cover

To use the rain cover:

1. Unzip the rain cover and insert the speaker. Make sure the grill is facing the front flap.

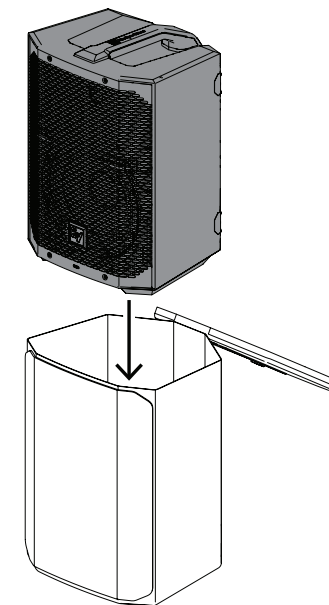

2. Zip the rain cover.

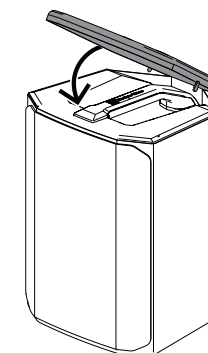

- Unzip the handle pocket and use the pocket to grab the handle.
The pocket goes under the handle.

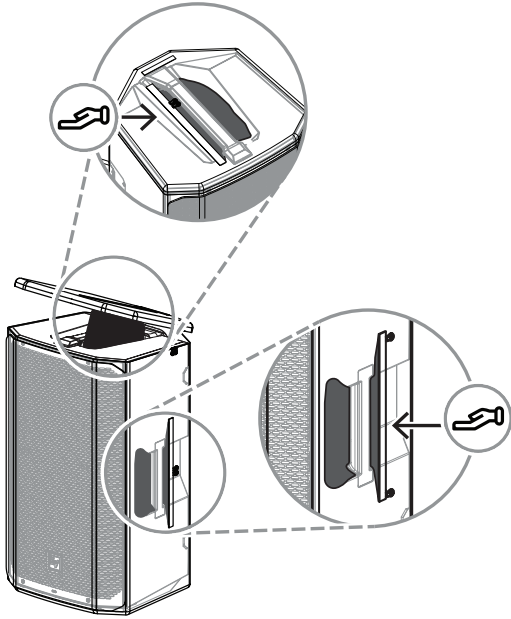

- Lift the front flap and fold it back over the top of the speaker.
- Attach the flap using the hook and loop at the back of the top of the speaker

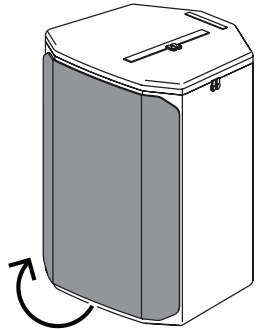

To use the speaker in tripod position:

- Open the bottom flap of the rain cover.

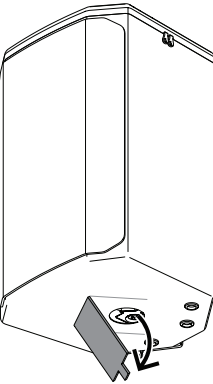

- Insert the speaker on a tripod.

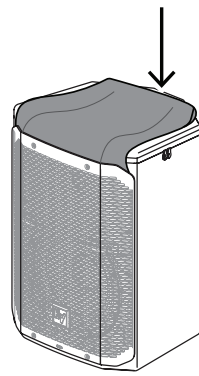
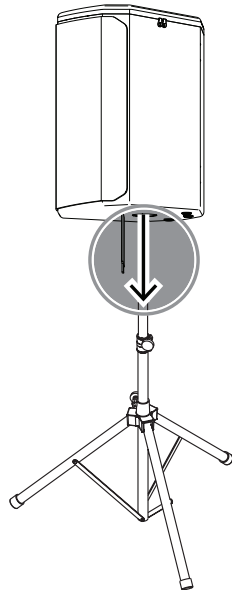

To connect the speaker:

- Unzip the amp pocket in the back of the rain cover.
- Make the required connections.
- Zip the amp pocket.

Technical data

	EVERSE8-RAINCVR Rain resistant cover for EVERSE 8
Color	Black
Material	600D poly with waterproof and hydrophobic treated lycra cloth
IP rating	IP44
Dimensions (H x W x D) (mm)	400 mm x 285 mm x 280 mm
Dimensions (H x W x D) (in)	15.75 in x 11.22 in x 11.02 in
Shipping dimensions (H x W x D) (mm)	480 mm x 425 mm x 28.5 mm
Shipping dimensions (H x W x D) (in)	18.9 in x 16.7 in x 1.12 in
Weight (g)	370 g
Weight (lb)	0.82 lb
Shipping weight (g)	420 g
Shipping weight (lb)	0.93 lb

	EVERSE12-RAINCVR Rain resistant cover for EVERSE 12
Color	Black
Material	600D poly with waterproof and hydrophobic treated lycra cloth
IP rating	IP44
Dimensions (H x W x D) (mm)	584 mm x 362 mm x 378 mm
Dimensions (H x W x D) (in)	23 in x 14.25 in x 14.88 in
Shipping dimensions (H x W x D) (mm)	23 mm x 570 mm x 590 mm
Shipping dimensions (H x W x D) (in)	0.90 in x 22.4 in x 23.23 in
Weight (g)	620 g
Weight (lb)	1.37 lb
Shipping weight (g)	680 g
Shipping weight (lb)	1.50 lb

EVERSE Rain cover

EVERSE8-RAINCVR, EVERSE12-RAINCVR

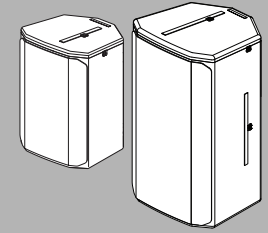

Quick user guide



Bosch Security Systems, LLC

130 Perinton Parkway
Fairport, NY 14450
USA

www.electrovoice.com

© Bosch Security Systems, LLC, 2023

EU importer:

Bosch Sicherheitssysteme GmbH

Robert-Bosch-Platz 1
70839 Gerlingen
Germany

© Bosch Sicherheitssysteme GmbH,
2023

