

CPS2T CONTRACTOR PRECISION SERIES

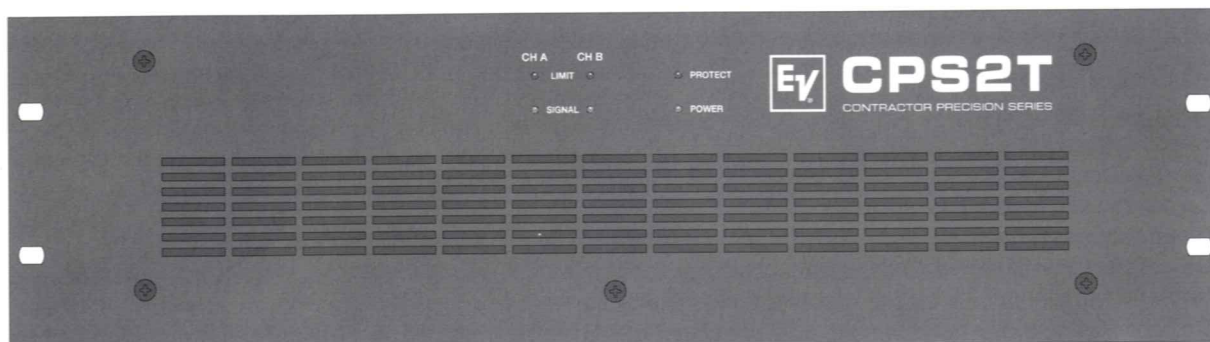

Features

- 2 x 600 watts output power capacity
- floating 100 V / 70 V / 25 V power outputs (isolated outputs)
- low impedance outputs (direct outputs)
- bridged mode operation, switchable
- mains supply 120V / 230 V AC 50/60 Hz
- POWER REMOTE function
- service mains switch
- active ventilation via 2 temperature-controlled DC-fans
- electronically balanced inputs
- routing switch for parallel linked operation
- input gain controls
- integrated audio limiters
- power-on switching noise suppression
- protection circuitry: DC/HF, Back-EMF, output voltage overload limiters, initial inrush current limiter, output peak current limiter, output transformer saturation protection (TSP)
- 18 dB/oct. HPF filter at 45 Hz
- SIGNAL and LIMIT indication for optical monitoring
- thermal overload protection for the heat sink and the internal power supply, with PROTECT-function
- input transformers for balanced, floating operation are optionally available
- XLR-type and binding post clamping input connectors
- 19" frame size, 3 RU

CONTENTS

Description	3
Installation Notes	4
Rear View	5
Inputs	5
Outputs	6
Specifications	25
Block Diagram	26
Dimensions	27
Warranty	28

IMPORTANT SAFETY INSTRUCTIONS

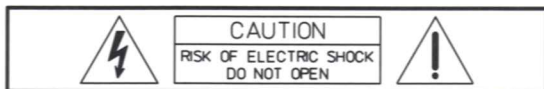

WARNING: TO REDUCE THE RISK OF FIRE OR ELECTRIC SHOCK,
DO NOT EXPOSE THIS APPLIANCE TO RAIN OR MOISTURE.
AVIS: RISQUÉ DE CHOC ELECTRIQUE. NE PAS OUVRIR.



The lightning flash with arrowhead symbol, within an equilateral triangle is intended to alert the user to the presence of uninsulated "dangerous voltage" within the product's enclosure that may be of sufficient magnitude to constitute a risk of electric shock to persons.



The exclamation point within an equilateral triangle is intended to alert the user to the presence of important operating and maintenance (servicing) instructions in the literature accompanying the appliance.

1. Read these instructions.
2. Keep these instructions.
3. Heed all warnings.
4. Follow all instructions.
5. Do not use this apparatus near water.
6. Clean only with a damp cloth.
7. Do not block any of the ventilation openings.
Install in accordance with the manufactures instructions.
8. Do not install near any heat sources such as radiators, heat registers, stoves, or other apparatus that produce heat.
9. Only use attachments/accessories specified by the manufacturer.
10. Refer all servicing to qualified service personnel. Servicing is required when the apparatus has been damaged in any way, such as power-supply cord or plug is damaged, liquid has been spilled or objects have fallen into the apparatus, the apparatus has been exposed to rain or moisture, does not operate normally, or has been dropped.

For US and CANADA only:

Do not defeat the safety purpose of the grounding-type plug. A grounding type plug has two blades and a third grounding prong. The wide blade or the third prong are provided for your safety. When the provided plug does not fit into your outlet, consult an electrician for replacement of the obsolete outlet.

IMPORTANT SERVICE INSTRUCTIONS

CAUTION: These servicing instructions are for use by qualified personnel only. To reduce the risk of electric shock, do not perform any servicing other than that contained in the Operating Instructions unless you are qualified to do so. Refer all servicing to qualified service personnel.

1. Security regulations as stated in the EN 60065 (VDE 0860 / IEC 65) and the CSA E65 - 94 have to be obeyed when servicing the appliance.
2. Use of a mains separator transformer is mandatory during maintenance while the appliance is opened, needs to be operated and is connected to the mains
3. Switch off the power before retrofitting any extensions, changing the mains voltage or the output voltage.
4. The minimum distance between parts carrying mains voltage and any accessible metal piece (metal enclosure), respectively between the mains poles has to be **3 mm** and needs to be minded at all times.
The minimum distance between parts carrying mains voltage and any switches or breakers that are not connected to the mains (secondary parts) has to be **6 mm** and needs to be minded at all times.
5. Replacing special components that are marked in the circuit diagram using the security symbol (Note) is only permissible when using original parts.
6. Altering the circuitry without prior consent or advice is not legitimate.
7. Any work security regulations that are applicable at the location where the appliance is being serviced have to be strictly obeyed. This applies also to any regulations about the work place itself.
8. All instructions concerning the handling of **MOS** - circuits have to be observed.

Note:  **SAFETY COMPONENT (HAS TO BE REPLACED WITH ORIGINAL PART ONLY)**

DESCRIPTION

Especially designed for permanent installations, the CPS2T power amplifier offers performance-consistent and reliable operation of PA-systems with 2 individual loudspeaker lines, each. Therefore, power amplifier is most suitable for company intercom, alarm and background music transmission installations in offices and commercial areas, congregation and sport centers, schools, houses of worship, hotels, hospitals, shopping malls and super markets, cruise ships, and other similar applications.

The CPS2T incorporates two high-performance output transformers. Next to 100 V, 70 V, and 25 V floating outputs, the direct outputs provide the possibility to also drive loudspeaker systems with low-impedance down to a minimum of 4 ohms. Simultaneous operation of low-impedance speaker systems and floating loudspeaker lines on a single output channel of the power amplifiers is possible as well.

The integrated 45 Hz High-pass filter with 18 dB/oct. slope protects the connected loudspeaker lines from unwanted ultra-low frequencies.

Comparator circuitry constantly monitors the input and output signals of the power amplifiers and activates their internal limiters whenever non-linear operation is encountered which reliably protects the connected loudspeaker systems against overload conditions and clipping, saturation of the output transformers, and overvoltage at the outputs. The employed comprehensive dimensioned power supply units with low-interference toroidal transformers ensure that the stated nominal performance specifications are accomplished, even in most demanding and critical installations. Since the CPS2T do not employ V/I-Foldback-Limiter circuits, operation on complex loads up to $\pm 90^\circ$ phase angles is possible without a problem.

Quick optical information on the power amplifiers' momentary operational status is provided through easily readable LED indicators, individually showing whether a channel is ready for operation, a signal is present at the output, if any of the limiter circuits and/or one of the protection circuits has been activated.

The inputs are electronically balanced and carried out as XLRF-type and as binding post clamping connectors as well. Parallel linking the two connector types at the input provides the possibility to utilize the carried-through signals to feed additional power amplifiers, without the necessity for special split-cables. Both inputs can be optionally retrofitted with input transformers. Through Input Routing switches it is possible to configure the CPS2T for stereo, parallel-monaural, or bridged-mode operation.

The dB-scaled level controls – extremely precise and good to operate potentiometers – are located on the rear of the appliances. A Ground-Lift switch, which helps eliminating ground noise loops by separating the amplifier circuit ground from the common ground of the enclosure, is also to be found on the rear panels. Conveniently connecting the loudspeaker lines to the power amplifiers is provided through a binding post strip, where all voltages – 25 V, 70 V, 100 V – and the low-impedance output are present on individual screw-clamp connectors. The rear panel service mains switches allow turning the power amplifiers' power on directly. Using the provided power remote input, remote-start is also possible.

Consistent thermal stability of the power amplifiers is obtained through extremely silent running fans which are automatically switched stepwise depending on the amplifiers' operation mode. The front-to-rear air circulation guarantees trouble-free operation in rack-shelf enclosures of any size.

Several other features of the CPS2T are revealed within this owner's manual. Therefore, please take the time to carefully and entirely read the provided information.

Installation Notes

Generally, it is important to install the power amplifier in a way, that ensures unhindered front-to-rear air circulation.

When installing the power amplifier in a closed rack-shelf system, please make sure that adequate air-flow is guaranteed. The space between the rear panel of the amplifier and the inner wall of the rack-case has to be at least 60 mm x 330 mm. A free space of at least 100 mm above the rack-shelf system is needed to provide sufficient air circulation. Since, during operation, the temperature inside the rack system could easily rise up to 40° C, the maximum allowable ambient temperatures of the rest of the incorporated modules and appliances within a specific rack-shelf system have to be taken into careful consideration.

When mounting the power amplifier inside of a closed rack system, it is recommended to use special rack-rails or optionally available rack-mount ears NRS 90235 (112733) to prevent bending of the appliance's front panel.

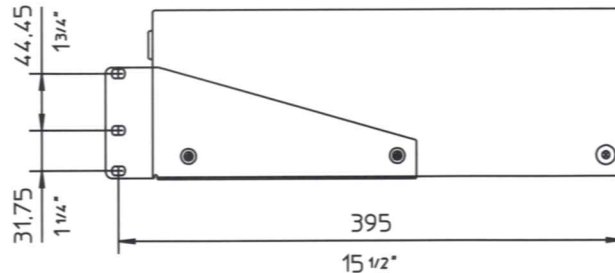

Note For maintained trouble-free operation of the appliance, the maximum admissible ambient temperature of +40°C is not to be exceeded.

The amplifier has to be protected from:

- water drops or splashes
- direct sunlight
- high ambient temperatures and the direct radiation of heat sources
- high humidity and moisture
- heavy dust
- massive vibrations

Moving the amplifier from a cold into a warm environment can result in the occurrence of condensation on inner parts. Operating the appliance is only permissible after it has accommodated to the altered temperature (approximately after one hour).

Should any foreign solid parts or liquids inadvertently intrude the enclosure, immediately unplug the device from the power source and have it checked at a Electro-Voice service center, before further use.

Cleaning the appliance should not be performed using chemical solvents or sprays, as this might damage the finish and could even cause hazard fire.

Before The First Operation

Before switching the amplifier's power on, the included mains cord has to be connected to the appropriate wall outlet. On the appliance itself, the cord has to be connected to the 3-pole mains socket.

To remotely start the amplifier, it is necessary to connect an external 24 V power source to the terminal strip POWER REMOTE. Providing correct connection and with an external power supply being present, the POWER ON indicator will light and the power amplifier is ready for operation.

The mains switch POWER on the rear of the appliance is meant for service and maintenance purposes only. Through bridging the mains switching relay this option provides the possibility to operate the amplifier without an external 24 V power supply connected.

Caution: The mains switch POWER on the rear of the appliance is **only** meant for maintenance. Remotely switching off the device is not possible when the POWER switch is engaged.

The CPS2T power amplifier employs a power-on switching delay of approximately 2 seconds.

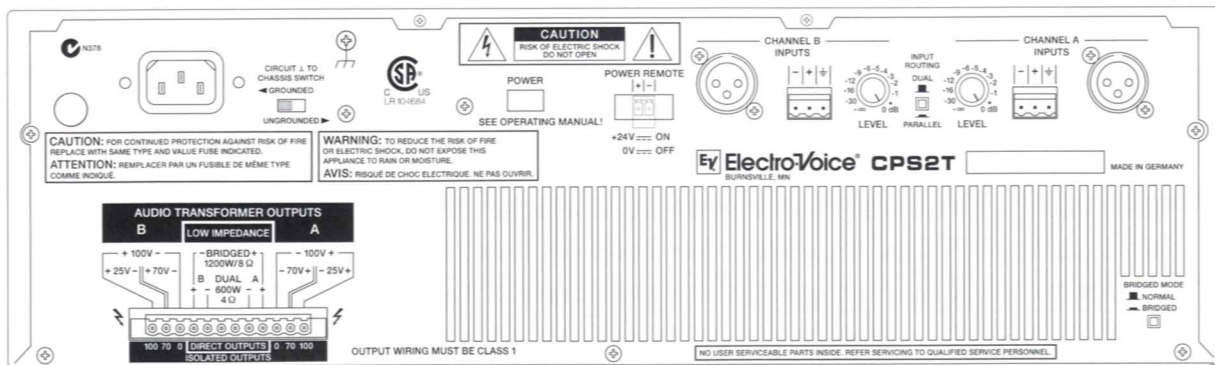

Inputs INPUT CHANNEL A&B

With an input sensitivity of 775 mV = 0 dBu and an input impedance of 20 kohms, the electronically balanced inputs – INPUT CHANNEL A&B – are meant for the connection of audio controllers, mixing consoles, etc.

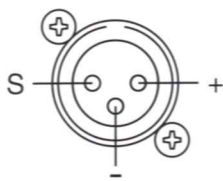

- PIN 1: SHIELD
- PIN 2: a, +
- PIN 3: b, -

Peripheral pieces of audio equipment are either connected via the XLR-type input connectors or using the parallel-linked binding posts. For the latter option you can utilize the supplied screw-plugs. Thus, carrying the audio signals through to feed additional power amplifiers can be conveniently achieved without the need for special split-cables.

The XLR-type input connectors' pin-assignment is in accordance to the IEC 268 standard:

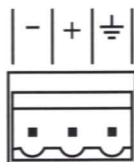

In case the controlling device does not supply balanced output connectors, it is also possible to configure the connectors for unbalanced operation. Therefore, the common ground (pin 1) has to be connected to the (-) input (pin 3). The audio signal is now solely fed through the (+) input (pin 2).

So, to be able to entirely make use of all the advantages the electronically balanced input stage offers – like the suppression of humming and interference noise – it is beneficial to re-establish balanced input connection whenever possible.

In case floating inputs are needed, the inputs are ready to be retrofitted with input transformers; one optional available extension kit NRS 90208 (308840) per channel is necessary.

Instructions On How To Install NRS 90208 Extension Kits

- unplug the power amplifier from the mains
- detach all screws holding the cover plate of the appliance
- lift and remove the cover plate
- disconnect the flat-wire cable of the printed board assembly 81340/1
- detach all screws holding the printed board assembly 81340/1
- remove the printed board assembly 81340/1 and unsolder the resistors R106 ... R109
- attach insulators to the input transformers according to the correspondent marks on the printed board assembly
- re-assemble the appliance by performing all steps described in the opposite order

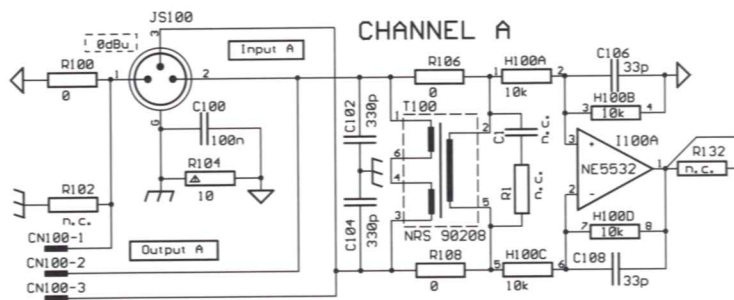

figure: schematic of input channel A

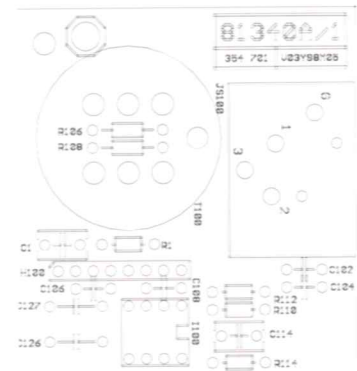

figure: printed board assembly area channel A – transformer retrofitting



Level Control

dB-scaled rotary controls for adjusting the power amplifier's overall amplification. This control should be positioned between the 0 dB and the -6 dB marks to prevent distortion in source devices. The labeling indicates the actual attenuation applied to the internal specified factor of amplification.

INPUT ROUTING

DUAL/STEREO



PARALLEL/MONO

Input Routing

If the switch is set to parallel/mono, the input connectors CHANNEL A and CHANNEL B are electrically linked for direct parallel operation. With only a single audio signal source connected, both channels are driven, while their volume levels are still individually controlled via the level controls A and B.

If the switch is set to its dual/stereo position, channels A and B are separately amplified (two channel or stereo mode).

Power Outputs A&B

The loudspeaker cables are connected to the power amplifier through high-performance binding posts – with the necessary screw-plugs being supplied. For connection purposes, it is possible to remove the 12-pole terminal plug. Cables with 2.5 mm² or AWG 13 can be utilized. To provide flexible connections, all floating output voltages – 25 V, 70 V, and 100 V (ISOLATED OUTPUTS) – as well as the low-impedance output (DIRECT OUTPUTS) of both channels are directly accessible.

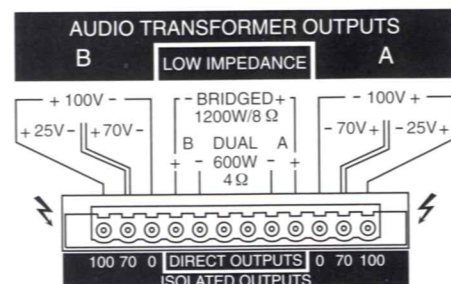

figure: power outputs of the CPS2T

Power Outputs - Isolated Outputs 25 V

The floating 25 V output is mainly used for driving low impedance loudspeaker systems (4 - 16 ohms). Because of the effect of line attenuation, the distance between power amplifier and loudspeaker systems should not exceed 50 meters. It is further important that the total impedance of the entire loudspeaker network does not decline the nominal load impedance of the 25 V output. For details on the nominal load impedance of the 25 V output, please also refer to the specifications in the appendix.

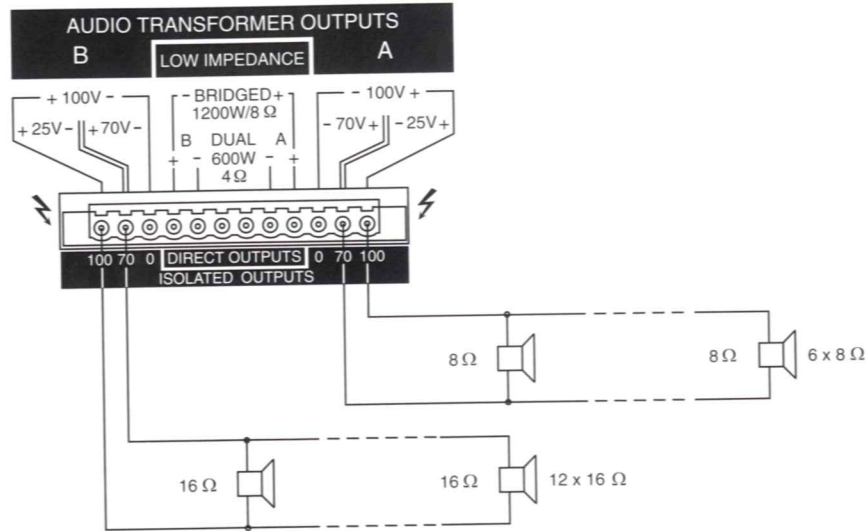

figure: example configuration – CPS2T with 8 ohms and 16 ohms loudspeaker systems at maximum load

Power Outputs – DIRECT OUTPUTS

In addition to the output transformer equipped outputs and for driving low impedance, high performance loudspeaker systems, the power amplifier's direct, low impedance outputs are carried out as well, offering a minimal load impedance of 4 ohms. Each power amplifier channel is capable of simultaneously driving loads at the direct output and at the isolated output. But it is of major importance that the overall power consumption of the connected loudspeaker systems or lines does not exceed the output power capacity of the power amplifier.

Example: If a loudspeaker system with 8 ohms and a nominal power handling capacity of 300 watts is connected to the CPS2T channel A Direct Output, this equals exactly half of the power amplifier's output power capacity since the minimal load impedance for each channel is 4 ohms. That leaves the possibility to utilize exactly half of the nominal output power capacity of the channel A 100 V output – which in this example equals $500 \text{ watts} / 2 = 250 \text{ watts}$ – to supply a split loudspeaker line. The total impedance of the loudspeaker line has not to decline $20 \text{ ohms} * 2 = 40 \text{ ohms}$.

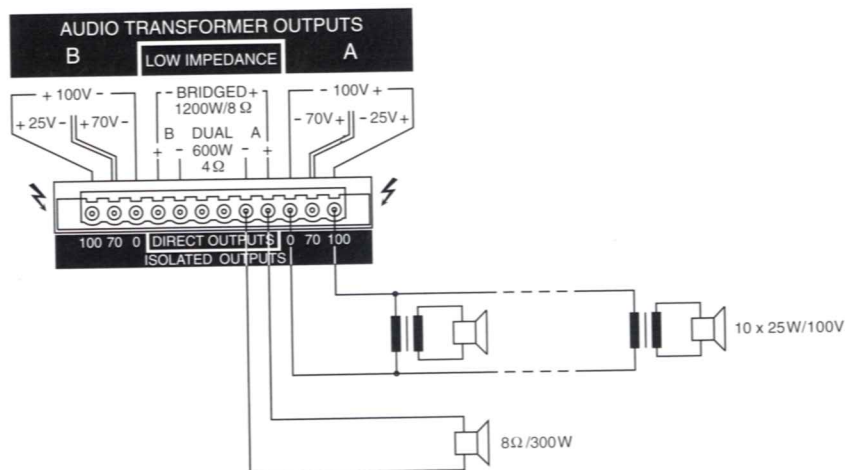

figure: example configuration – CPS2T channel A in mixed mode

Bridged Mode

Doubling the power amplifier's output power is accomplished by engaging bridged mode operation, where the two power amplifier output stages are linked for push-pull operation. In other words, a monaural power amplifier is "created" offering double the output voltage and double the output power capacity of a single channel. As a result you are provided with floating 50 V, 140 V, and 200 V as well as with a direct output with doubled nominal output voltage.

If the BRIDGED-MODE switch is engaged, the audio input signal has to be fed via the CHANNEL A input while the CHANNEL B input is without function. The signal is internally inverted and the power amplifier stage A is still driven by the unaltered incoming audio signal. Bridged mode operation is possible with using the isolated and/or the direct outputs.

When using the isolated outputs, bridging the (-) binding posts of channels A and B is mandatory, using short cables with suitable diameter !

Careful consideration of the loudspeaker systems' correct connection is important in preventing phase correlation problems. Channel A carries the signal "in phase" and therefore has to be connected to the (+)-pole of the correspondent loudspeaker system while the loudspeakers (-)-pole has to be connected to the (+)-output connector of channel B. The output voltage of each power amplifier stage A&B is present at the binding post strip, but utilization is not recommended because of the negative correlation.

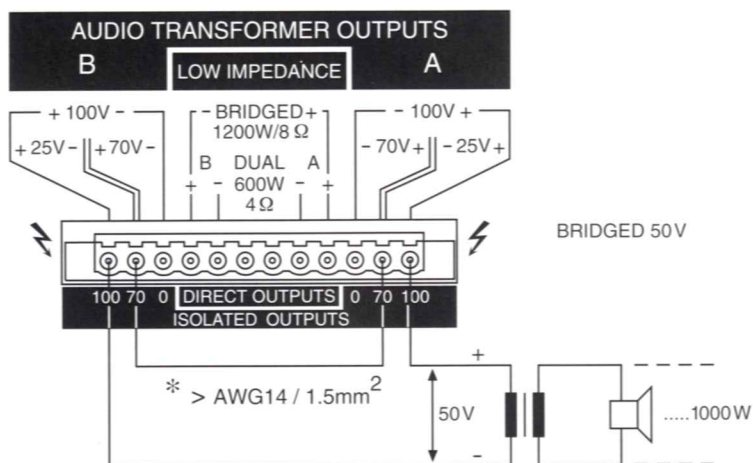
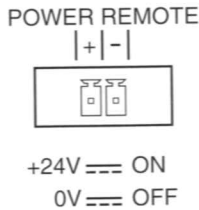
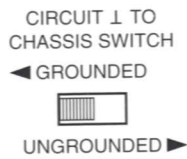

figure: output connection in 50 V bridged mode operation

***Caution!** The bridging cable has to be at least 1.5 mm² or AWG 14 in diameter.

Driving 4 ohms loads at the direct output is not admissible in bridged mode operation. For details on nominal load impedance and nominal loads of the individual outputs in bridged mode operation, please refer to the specifications in the appendix. Also in bridged mode, the nominal load impedance is not to be declined.



GROUND Lift Switch

The ground lift switch is a perfect means for eliminating possible ground noise loops. In case the power amplifier is operated together with other equipment inside of a rack shelf system, the switch should be set to its GROUNDED position. When using the power amplifier together with other equipment that operates on different ground potentials, the switch should be set to UN-GROUNDED.

Power On And Remote Control

When the power amplifier is operated via power remote start (standard operation) an external 24 V power source has to be connected to the POWER REMOTE terminal strip and the mains switch has to be set to its OFF-position. When correctly connected and with a present supply voltage, the power amplifier is operational. The fans run for approximately 2 seconds and the POWER ON-LED on the front panel lights. The mains switch POWER on the rear of the appliance bridges the mains relay. It is meant for service purposes only. This allows to operate the power amplifier without the presence of an external 24 V power source. The current consumption at the POWER REMOTE input is approximately 25 mA.

Limit Indicator

The indicator lights whenever the integrated limiter is activated. While short blinking means no problem, the continuously lit LED indicates that the volume level needs to be reduced to prevent the connected loudspeaker systems from being damaged by overload.

The audio limiters are capable of controlling overdrive levels of up to 20 dB. Most other power amplifiers without integrated limiters begin to clip, generating nasty distortion which might lead to damaging the connected loudspeaker systems by overload. The limiters are activated only in case of the occurrence of non-linear conditions within the power amplifier; e. g. signal clipping at the operation voltage limit. The limiters do not affect the power amplifier's overall dynamic range.

Signal Indicator

This indicator is lit when the audio signal exceeds -30 dB. In case short-circuits resulting from broken loudspeaker cables are detected or one of the power amplifier's protection circuits is activated, the signal indicator is dimmed.

PROTECT

The PROTECT-LED lights whenever one of the power amplifier's protection circuits – thermal overload, RF, DC, Back-EMF – is activated. In PROTECT mode all loudspeaker lines and output transformers are disconnected via relays and the power amplifier's audio inputs are short-circuited to prevent the connected loudspeaker systems from being damaged. When the power amplifier enters the PROTECT mode please examine first whether the appliance is overheated. If this is the case, the front and rear ventilation louvres are possibly covered, the nominal load impedance has fallen below the specified minimum value, or a short-circuit occurred at the power output.

When switching the power amplifier on, the PROTECT-LED lights for approximately 2 seconds. This is normal. It signals that the protection circuitry is in working order.

Power ON Indicator

This LED lights when the power amplifier is connected to the mains and its power switch is set to the ON-position. If the indicator does not light although the power amplifier is switched on, the appliance is not connected to the mains or the primary fuse is blown.

Protection Circuitry

The CPS-Series power amplifiers are equipped with extensive protection circuitry:

- initial current inrush limiter
- power-on delay
- RF and DC protection
- Back-EMF protection
- limiters for the audio signals
- output peak-current-limiters
- thermal overload of the heat sink
- thermal overload of the mains transformer
- output voltage overload limiters
- output transformer saturation protection (TSP)

High-level signals in the low frequency range can drive the output transformers of power amplifiers that do not provide audio signal limiters into saturation, resulting in nasty distortion and high thermal load of the power amplification stage. The audio signal limiters of the CPS2T power amplifier are designed to quickly identify the occurring saturation of the core of an output transformer. The level is dynamically reduced to a value, that stays just below the point of where the saturation starts. The Limit-LEDs on the front panel indicate that the limiters have been activated. Despite the protection that is provided through the audio signal limiters, the Limit-LEDs should not light over a longer period of time. Please, locate the cause of the faulty operation – e. g. lower the LF-EQ setting at the connected mixing console when at the same time the input level at the power amplifier is approximately +10 dB above the nominal input level.

The CPS2T power amplifier employ integrated High-Pass- filters at 45 Hz with 18 dB/oct. for each channel. They protect the loudspeaker systems that are connected via output transformers against low-frequency audio signals, which, depending on the quality and size of the involved transformers, could lead to problems with core saturation. In addition to the 45 Hz High-Pass- filters, the frequency response of the CPS2T power amplifier top margin is set by 30 kHz Hi-Cut filters with 12 dB/oct., preventing unwanted high-frequency audio signals from being present at the outputs.

Mains Operation And Leakage Power

The mains power consumption as well as the leakage power is stated for driving the power amplifier at different levels. All the values were measured at nominal load via the 100 V output with two channels driven. The shown values differ only slightly when the appliance is operated at different nominal output voltages or in the Direct Out mode.

mains operation at the 100 V output	U _{mains} [V]	I _{mains} [A]	P _{mains} [VA]	P _{mains} [W]	P _{out} [W]	P _v [W]	BTU/hr
CPS2T							
idling	230V 120V	0,57 1.1	131	80	—	80	273
normal operation (-10 dB)	230V 120V	3,66 7.0	842	655	101	554	1890
nominal conditions	230V 120V	9,86 18.9	2268	1900	1000	900	3070

Extension Kits For The CPS2T:

NRS 90208 balanced input (input transformer for a single channel)

NRS 90235 1 pair of rack-mount ears

Technical Specifications: CPS2T

Amplifier at rated conditions, both channels driven, direct outputs with 8Ω loads, isolated outputs with rated load and voltage, unless otherwise specified.

DUAL MODE

Output Definition

Load impedance or rated output voltage

Rated Load Impedance

isolated outputs only

Maximum Midband Output Power

THD=1%, 1kHz

Maximum Midband Output Voltage

THD=1%, 1kHz, RMS, rated load

Rated Output Power

THD <0.2%, 45Hz ... 20kHz,

Rated Output Voltage

THD<0.2%, 45Hz ... 20kHz

Maximum RMS Voltage Swing

THD=1%, 1kHz, no load connected

Frequency Response, -3dB, ref.1kHz

HPF-Filter: 18dB/octave, 45Hz LPF-Filter: 12dB/octave, 30kHz

Voltage Gain

at 1 kHz

Input Sensitivity and Impedance

at rated condition

Slew Rate

Power Bandwidth

THD=1%, ref. 1kHz, half power @ rated load impedance

THD at rated output power, MBW=80kHz, 1 kHz

IMD-SMPTE 60 Hz, 7 kHz

DIM30 3.15 kHz, 15 kHz

Crosstalk

ref. 1kHz, at rated output power

Input Impedance

20Hz ... 20 kHz, balanced

Damping Factor

at 100Hz / 1kHz, direct outputs only

Insertion Loss

isolated outputs only

Signal to Noise Ratio

Rated output voltage to noise, A-weighted

BRIDGED MODE

Output Definition

Load impedance or rated output voltage

Rated Load Impedance

isolated outputs only

Rated Output Power

THD<0.2%, 45Hz ... 20kHz

Maximum Bridged Output Power

THD=1%, 1kHz

Power Requirements

Power Consumption

at 1/8 maximum output voltage @ rated load impedance

Protections

Audio limiters, High temperature, DC, HF, Back-EMF,

Peak current limiters, Inrush current limiters, Turn-on delay, Output Transformer Saturation Protection (TSP)

Input Connectors

Output Connectors

Cooling

Mounting Depth with Connectors

Mounting Depth without Connectors

Dimensions (W x H x D)

Weight (net)

		CPS2T				
		Direct Output		Isolated Outputs		
		8Ω	4Ω	100V	70V	25V
				20Ω	9.8Ω	1.25Ω
		330W	600W	590W	580W	570W
		51.3V	49V	109.5V	75.4V	26.7V
		300W	500W	500W	500W	500W
		49V	44.7V	100V	70V	25V
			52V	121V	88V	32V
		45 Hz ... 30kHz		45 Hz ... 22kHz		
		35 dB	35 dB	42 dB	39 dB	30 dB
		0dBu (775mV) / 20 kOhm				
		30 V/μs				
		45Hz ... 50kHz		45Hz ... 25 kHz		
		< 0.05 %		< 0.1%	< 0.2%	< 0.3%
		< 0.08%		< 0.1%	< 0.3%	< 0.5%
		< 0.03 %		< 0.2%	< 0.3 %	< 0.3%
		< -80dB				
		20 kOhm				
		> 300 / > 200				
		0.7 dB		0.8 dB	1.1 dB	
		> 100 dB				
		Direct Output		Isolated Outputs		
		8Ω	200V	140V	50V	
		—	40Ω	19.6Ω	2.5 Ω	
		600W	1000W	1000W	1000W	
		1200W	1180W	1160W	1140W	
		120V / 230V / 50Hz...60Hz				
		870 W				
		Euro-style, 3pin, detachable or XLR				
		Euro-style, 12pin, detachable, covered				
		Front-to-Rear, 3-stage-fans				
		437 mm				
		377 mm				
		483mm x 132.5mm x 382mm				
		22.5kg (50lbs)				

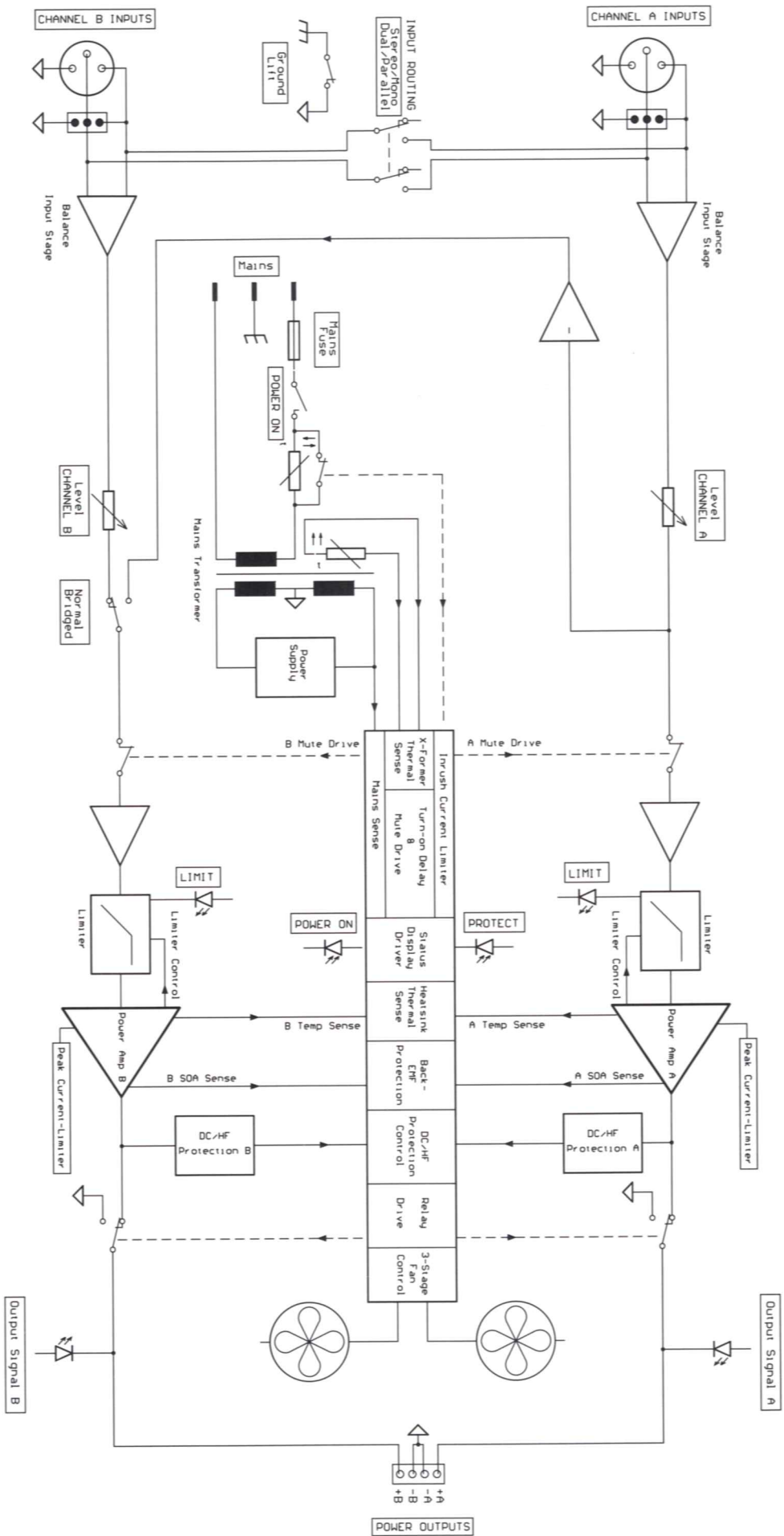

**BLOCK DIAGRAM
CPS2T**

Dimensions (in mm)

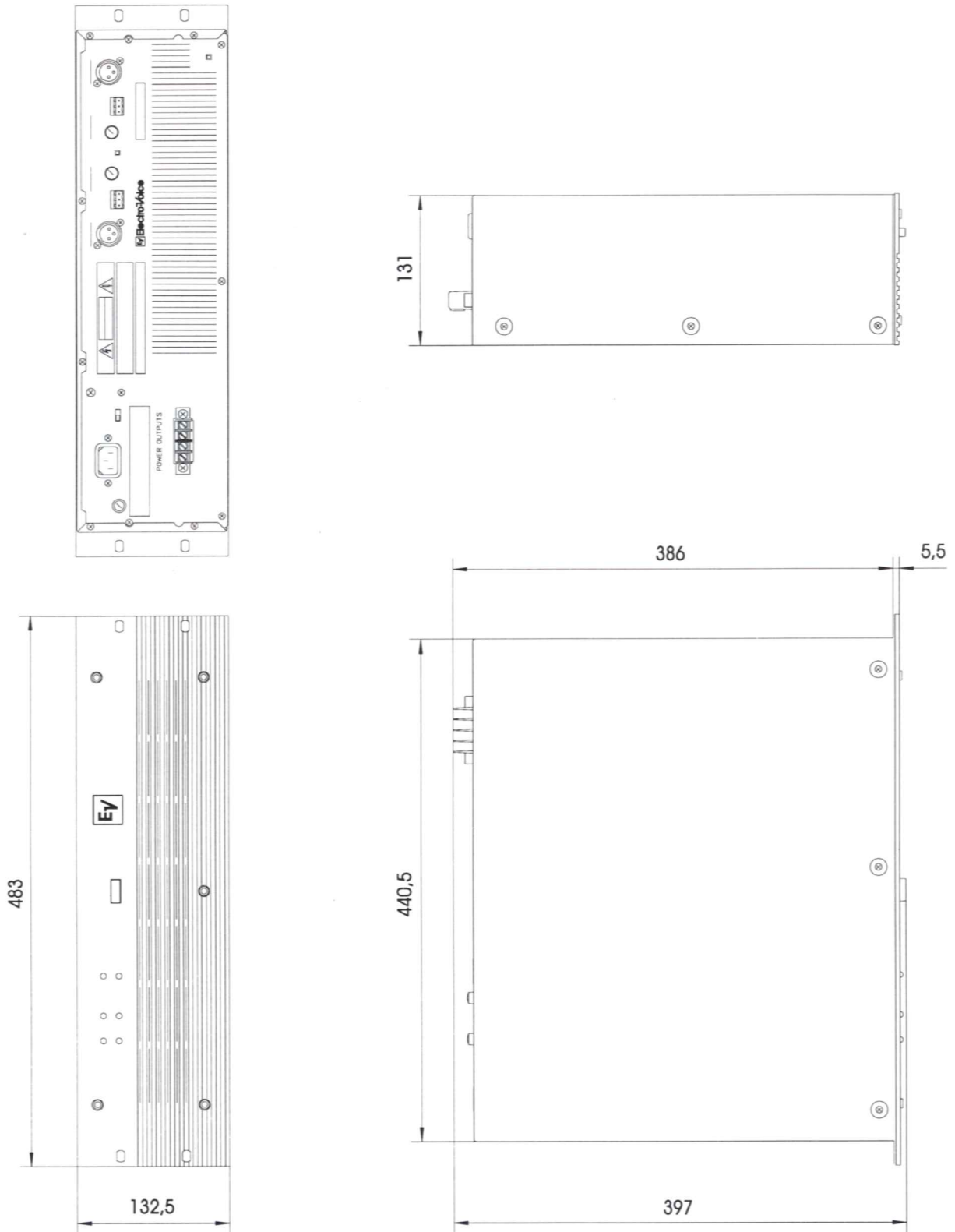

WARRANTY (Limited)

Electro-Voice products are guaranteed against malfunction due to defects in materials or workmanship for a specified period, as noted in the individual product-line statement(s) below, or in the individual product data sheet or owner's manual, beginning with the date of original purchase. If such malfunction occurs during the specified period, the product will be repaired or replaced (at our option) without charge. The product will be returned to the customer prepaid.

Exclusions and Limitations: The Limited Warranty does not apply to: (a) exterior finish or appearance; (b) certain specific items described in the individual product-line statement(s) below, or in the individual product data sheet or owner's manual; © Malfunction resulting from use or operation of the product other than as specified in the product data sheet or owner's manual; (d): malfunction resulting from misuse or abuse of the product; or (e): malfunction occurring at any time after repairs have been made to the product by anyone other than Electro-Voice or any of its authorized service representatives.

Obtaining Warranty Service: To obtain warranty service, a customer must deliver the product, prepaid, to Electro-Voice or any of its authorized service representatives together with proof of purchase of the product in the form of a bill of sale or receipted invoice. A list of authorized service representatives is available from Electro-Voice at 600 Cecil Street, Buchanan, MI 49107 (616-695-6831) and/or Electro-Voice West at 9130 Glenoaks Boulevard, Sun Valley, CA 91532 (213-875-1900).

Incidental and Consequential Damages Excluded: Product repair or replacement and return to the customer are the only remedies provided to the customer. Electro-Voice shall not be liable for any incidental or consequential damages including, without limitation, injury to persons or property or loss of use. Some states do not allow the exclusion or limitation of incidental or consequential damages so the above limitation or exclusion may not apply to you. **Other Rights:** This warranty gives you specific legal rights, and you may have other rights which vary from state to state.

Electro-Voice Electronics are guaranteed against malfunction due to defects in materials or workmanship for a period of three (3) years from the date of original purchase. Additional details are included in the Uniform Limited Warranty Statement.

Specifications subject to change without notice.

Electro-Voice®

GERMANY	EVI AUDIO GmbH • Hirschberger Ring 45 • D-94315 Straubing, Germany • Shipping: D-94315 • Tel.: 0 11 49 / 94 21 / 70 60 • FAX: 0 11 49 / 94 21 / 70 62 65
AUSTRALIA	EVI AUDIO (Aust.) Pty. Ltd. • Unit 23, Block C • P.O. Box 6427, Slough Avenue • Silverwater, N.S.W. 2128 Australia • Tel.: 0 11 61 / 2 - 6 48 - 34 55 • FAX: 0 11 61 / 2 - 6 48 - 55 85
CANADA	Telex / EVI Canada • 705 Progress Ave. • Unit 46 • Toronto, Ontario, M 1 H 2 X 1 • Tel.: 800 / 8 81 / 16 85 • 416 / 4 31 - 49 75 • FAX: 877 / 5 22 - 22 42 • 416 / 4 31 - 45 88
FRANCE	EVI AUDIO France, S.A. • Parc de Courcerin-Allee Lech Walesa • 77185 Lognes • Tel.: 0 11 33 / 1 - 64 80 - 00 90 • FAX: 0 11 33 / 1 - 60 06 - 51 03
HONG KONG	EVI AUDIO Hong Kong (ACCL) • Flat E & F, 21 / F., Luk Hop Industrial Bldg. • 8 Luk Hop St., San Po Kong • Kowloon, Hong Kong • Tel.: 0 11 852 / 3 51 - 36 28 • FAX: 0 11 852 / 3 51 - 33 29
JAPAN	EVI AUDIO Japan, Ltd. • 2 - 5 - 60 Izumi • Suginami-ku, Tokyo, Japan 168 • Tel.: 0 11 81 / 3 - 33 25 - 79 00 • FAX: 0 11 81 / 3 - 33 25 - 77 89
MEXICO	Telex Communications Mex. • Tecnologia Especializada • de la Ciudad de Mexico • 15520 DF Mexico • Tel.: 0052/53 58-54 34 • FAX: 0052/53 58-55 88
SINGAPORE	Telex Communications • (Sea) Pte Ltd. • Industrial Estate • 408705 Singapore • Tel.: 0065/7 46 87 60 • FAX: 0065/7 46 12 06
U. K.	Shuttlesound Ltd. • 4, The Willow Centre • Willow Lane, Mitcham Surrey, CR4 4NX • Tel.: 00 44 / 20 / 86 46 71 14 • FAX: 00 44 / 20 / 86 40 75 83
UNITED STATES	Telex Communications Inc. • International Operations • 12000 Portland Avenue South • 55337 MN Burnsville • Tel.: 001 / 50 75 26 32 05 • FAX: 001 / 50 75 26 30 59