

Line Arrays

Line Arrays — History and Theory

Mention is made of the vertical orientation of sound sources as far back as 1896. Line arrays were also popular in the 1950s and 60s because of the ability to provide excellent vocal range intelligibility in reverberant spaces. **Figure 1**, **Figure 2** and **Figure 3** are excellent representations of high performance “vocal range” line arrays. These line arrays, like all vertically oriented sources in the past were, what could best be termed, limited bandwidth line arrays.

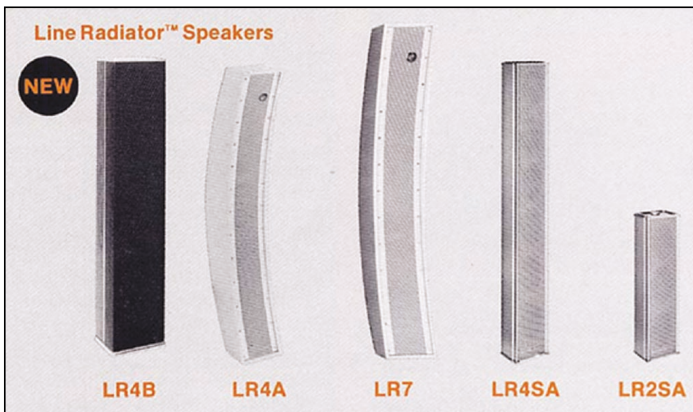

Figure 1

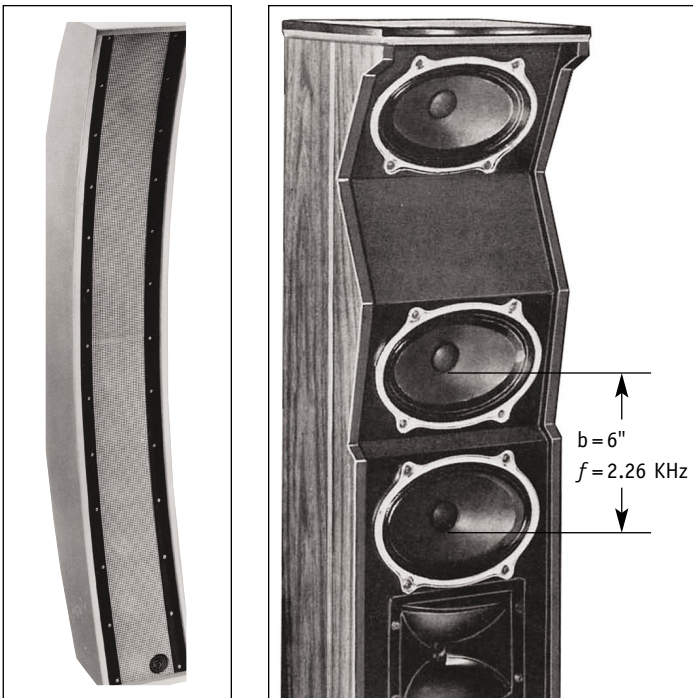

Figure 2

Figure 3

Figure 3 shows an Electro Voice line array from the 1970s. It represents a relatively elegant solution to achieving high vocal intelligibility. It should be noted that the source separation of

this design is roughly six inches, relating to a wavelength of 2.26kHz. The line array behaved very well up to that 2 kHz range.

It should also be noted in the **Figure 3** that a high frequency horn was employed above that frequency limit in order to achieve appropriate extended bandwidth and fidelity up to and beyond 10 kHz. This is a classic embodiment of a limited bandwidth line array and as we shall see in this presentation, only recently have solutions been brought to the state of the art to enable line array technology to truly be full bandwidth and extend beyond the 10-15 kHz region.

Before we begin discussing bandwidth for modern day line arrays, it is important to begin with a discussion of basic radiation of sound. **Figure 4** represents a spherical shape whose radius “r” can vary with time.

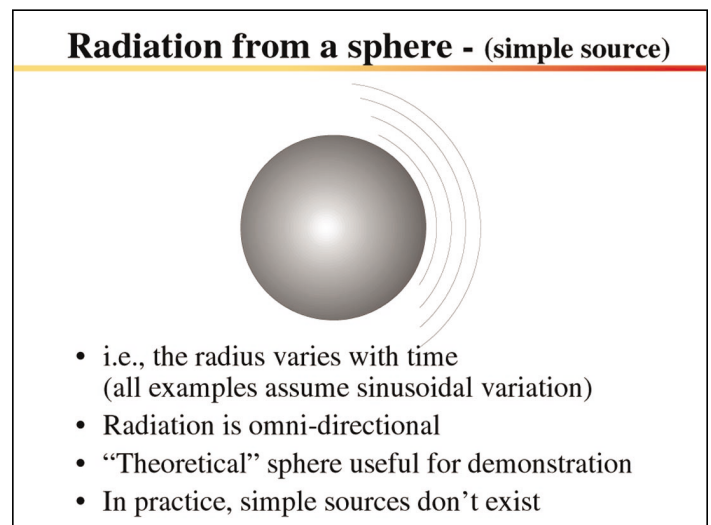

Figure 4

Figure 5, Equation 1 describes the acoustical performance of this pulsating sphere. This pulsating sphere, or simple source is a useful theoretical tool describing the mathematics of radiating sound.

Figure 5, Equation 1

$$\rho_{AV} = \frac{(ka)^2}{1 + (ka)^2} \text{ p.c (Vs}^2\text{) ave (}4\pi a^2\text{)}$$

Where: $K = w/c$

ρ_{AV} = time averaged power

V_S = velocity

Figure 5, Equation 2

Condition: $Ka \ll 1$

or

$\lambda \gg a$

One of the key requirements of this pulsating sphere, or simple source, is that KA is always much less than 1 (**Figure 5, Equation 2**). That is to say the wavelength must always be much greater than the dimensions of the radiating device itself. An ideal simple source is almost infinitely small and thereby meets the requirement that KA is always much, much less than 1.

Simple sources, of course, don't exist in the real world as radiating devices always some dimension and those dimensions, in order to radiate sufficient acoustic power, become large compared to most audio frequencies. (It is important to define the term high frequency and low frequency at this point. When one considers the term high frequency, one always assumes a particular value associated with that frequency. One could assume 5 kHz to be a relatively high frequency and it certainly would be if the radiating device were an 18-inch direct radiating loudspeaker. 5 kHz conversely, is a very low frequency if the device radiating that wave front were a very small dimension, a high frequency super tweeter, for example. The important thing to note here is that the term high frequency or low frequency is a term that describes the wavelength in comparison to the dimensions of the radiating device itself. Throughout this discussion of line arrays, whenever the term high or low frequency is used, it is always assumed that a low frequency has an associated wavelength much longer than the dimensions of the radiating source and the term high frequency relates to wavelengths that are much shorter than the dimensions of the radiating source.)

Figure 6 is an Array Show representation of a theoretical simple source. As can be seen from this slide, the radiation is purely omnidirectional, implying that any wavelength radiated is always long compared to the dimensions of the radiating device. It is common in sound reinforcement practice to assume that subwoofers or bass enclosures are essentially omnidirectional.

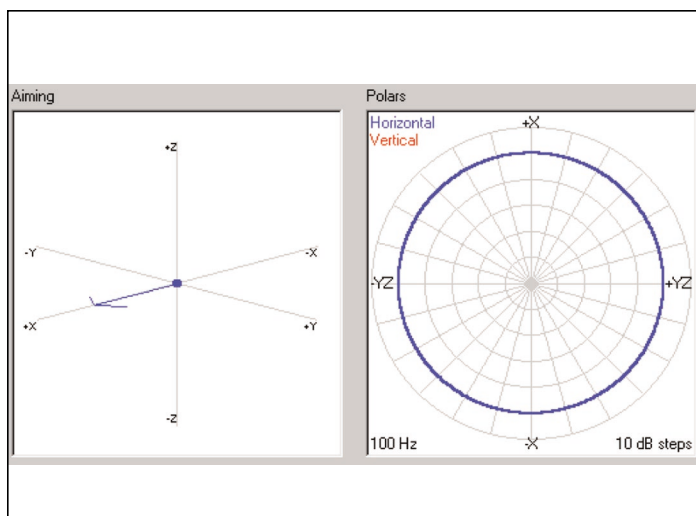

Figure 6

Figure 7 shows an Electro Voice XDS subwoofer enclosure. Although the 100 Hz being radiated is a relatively low frequency (wavelength approximately 11.3 ft), examination of the associated polar in this figure shows that the radiation at + and - 90 degrees from the central axis is 6dB to 7dB down from that on axis and the radiation at 180 degrees opposite the main lobe is also 7dB to 8dB down. The XDS is a relatively large subwoofer from a physical standpoint. (36"H x 45.92"W x 29.88"D). The radiator is not omni directional.

To further illustrate the point, **Figure 8** shows an Electro Voice TL15-1 base enclosure. This is a single 15-inch, direct radiating enclosure of very small dimension. It can still be seen from examination to polar response in this figure that the response at +/- 90 degrees is still 3 dB down from that on axis. Again, not omni directional radiation. These figures, indicate the importance of the radiated frequencies being substantially longer than the dimensions of the device if true omni directional radiation is to occur. Given the initial descriptions of these theoretical simple sources or pulsating spheres it is now appropriate to bring a second sphere into the discussion.

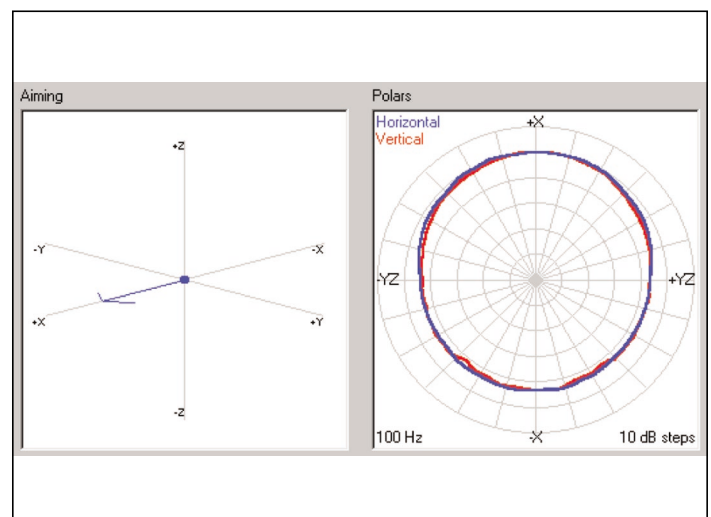

Figure 7

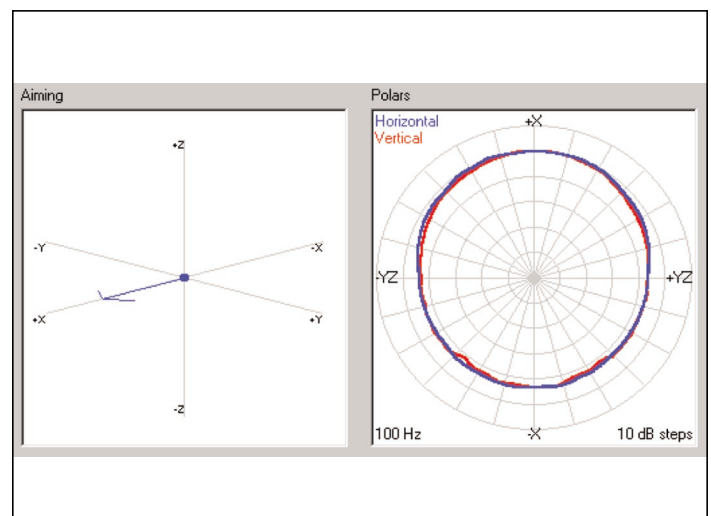

Figure 8

Figure 9 represents two spheres or simple sources separated by a distance B . The assumption here is that B is always much, much less than the radiated wavelengths. If this condition occurs, then the two point sources will generate double the pressure and the directivity is still that of a single point (omni). This is a simple and intuitive case where two radiating sources simply generate twice the pressure of the single source.

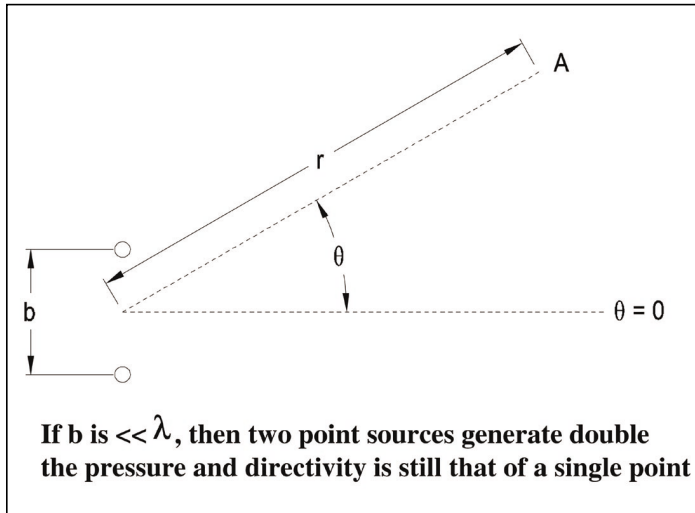

Figure 9

Figure 10 shows these two point sources separated by a distance of 12 inches. The polar response shown is that of those two point sources radiating 100 hz signal. Again, the space in B is much, much less than the wavelength, and as a result, the radiation continues to be that of an omni-directional condition. (Again, this is only a theoretical case, as point sources do not exist in practice.) This representation is extremely useful when we look at **Figure 11**, which is the same two point sources as that of **Figure 10**. The distance continues to be 12 inches, but now the frequency has been raised to 630 hz. (B approximately equivalent to $1/2$ of the wavelength.)

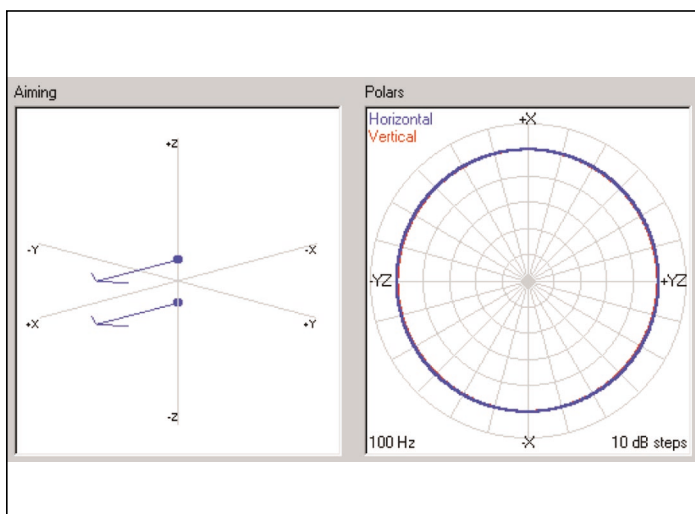

Figure 10

Examination of **Figure 11** shows that at 0 degrees on axis and at 180 degrees the radiation is summing coherently and the radiation at -90 degrees and $+90$ degrees ($-y/+y$ on the Array Show polar plot) is experiencing cancellation. The radiation of $+x$ and $-x$, or that of the radiation on axis, has seen a 3 dB gain in pressure associated with the pressure addition of the two sources. **Figure 11** begins to illustrate the principles underlying successful application of a continuous line of vertical sources (that of a line array).

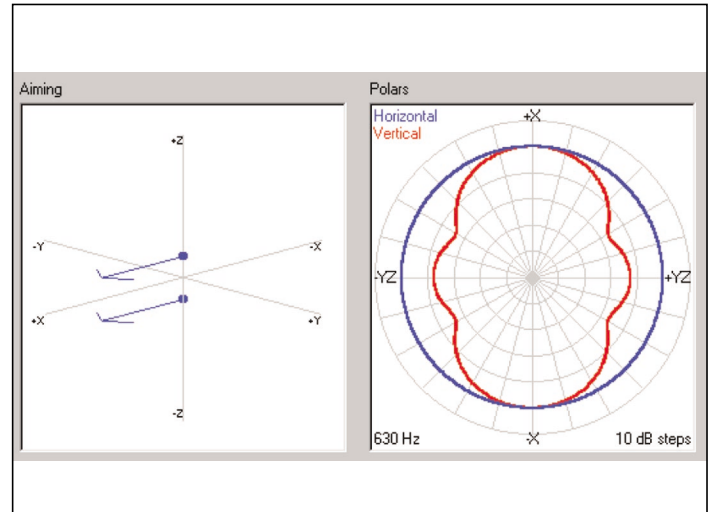

Figure 11

Figure 12 is extremely interesting as well as it explains the “historical” applications where line arrays were limited bandwidth devices, such as those referenced in **Figure 1**, **Figure 2** and **Figure 3** earlier in this discussion. The two point sources continue to be spaced by 12 inches, but now the frequency has been raised to 2500 hz. In this case, the space B is equal to twice the wavelength. Examination of the polar response shows substantial polar lobing errors. It describes exactly the response of any group of sources, whether they are vertically oriented or horizontally oriented when the wavelengths become shorter than the device spacing.

Figure 12 is a clear representation of difficulties that system designers face when trying to provide full bandwidth radiation (i.e. greater than 16 kHz) with real world radiating sources. The peaks and nulls in the diagram of **Figure 12** are easily heard in real world applications and have always been taken as a “necessary evil” when orienting sources. The previous polar diagrams also require some explanation.

In definition of terms, **Figure 13**, the beamwidth is defined as the included angular separation between the -6 dB points, reference to the 0 db ($+x$) axis. The term Q is the ratio of the acoustic intensity on that reference axis at some reference distance to a true point source radiating the identical acoustic power. Again, the true point source is useful from a mathematical standpoint to enable us to define the acoustic intensity ratio of real world devices to theoretical omni

directional radiators. Of most interest when designing line arrays is the term directivity index. The directivity index, $di = 10 \log_{10}(Q)$, represents the acoustic gain associated with the increased directional radiation of higher Q devices.

The fundamental operation of a vertical source of radiators or a line array depends heavily on gain related to directivity index. These gains, of course, are also dependent on having the directivity index be constant with regards to frequency. (Constant gain versus frequency is a critical operating parameter for uniform SPL distribution).

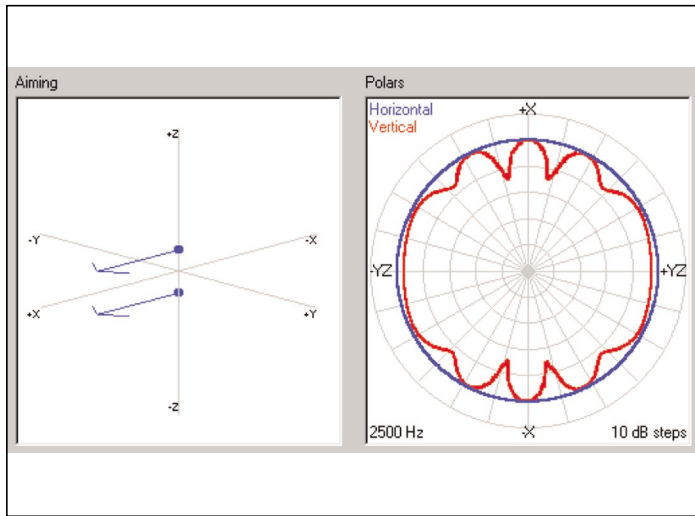

Figure 12

- Beam width
 - included angular separation between -6dB points as referenced to 0dB
- Q
 - ratio of acoustic intensity on reference axis (at reference distance) to a true point (simple source) radiating identical acoustic power
- Directivity Index (DI)
 - $DI = 10 \log_{10}(Q)$

Figure 13

Figure 14 is another Array Show representation illustrating the concept of beamwidth, Q and directivity index. Here two point sources, again spaced 12 inches apart, are shown. The applied frequency is 1250 Hz. In this condition the spacing B is approximately the equivalent to the wavelength associated with 1250 Hz. In Figure 14 the beamwidth is 30 degrees, the Q is 2 and the directivity index associated with that Q is slightly over a 3 dB gain.

It can also be seen from Figure 14 that the lobing pattern

begins to suggest that spacings greater than those equal to the radiated wavelength begin producing unacceptable polar lobing errors. For this reason, successful application of full band with line arrays requires that the spacing always be less than the radiated wavelengths. Figure 15 now takes our two point sources and begins to build a continuous vertical orientation of sources. Although still theoretical in nature, the representation shown in Figure 15 is exactly what is used to generate the proper mathematical description of the line array. The sources still have a separation of B but now we've replaced two sources with N number of sources. A theoretical line array occurs when the spacing B tends toward 0 and the number of sources grow towards infinity. Again, although both conditions are impossible to satisfy in real world applications, the designer's challenge is to approximate small source separation and as great a number of sources as geometry, physical spacing, and safe hanging practice will allow. It should also be noted that one of the key points to all line array discussions is noted in Figure 15, and that is all sources must be both equal in magnitude and of equal phase.

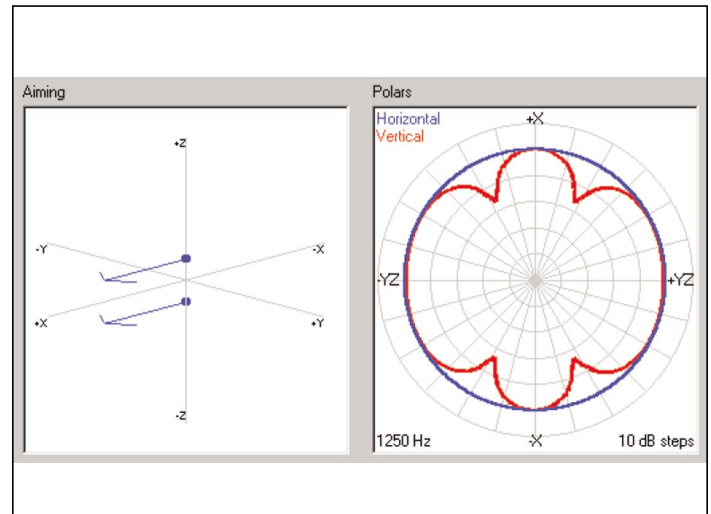

Figure 14

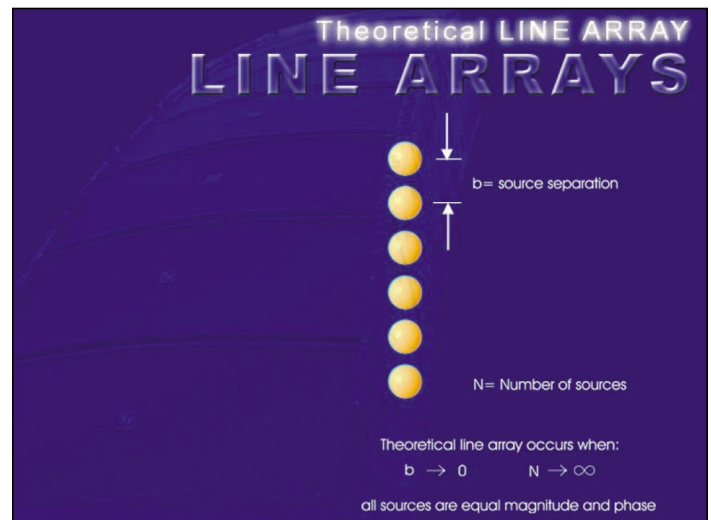

Figure 15

This last condition is the key to all line array analysis, at least from a theoretical standpoint. Subsequent discussions of the line array performance will demonstrate what this condition of equal magnitude and phase rarely, if ever, occur.. **Figure 16** shows a theoretical line array with a large number of vertically oriented sources. The radiation frequency associated with this figure is 630 Hz. Examination of the polar pattern shows very controlled response with very minimal lobing error. Appropriate examination of this polar for a line array is in the quadrant from +x to -y (in the Array Show plot). This is the section of any line array that is used for audience coverage.

Given the definition of the line arrays previous discussed, we can now begin to look at practical line arrays and their applications. As noted, we cannot achieve source separation approaching 0 nor the number of sources approaching infinity. Practical line arrays or those realizations of line arrays occur when the space in B is less than the radiated wavelength.

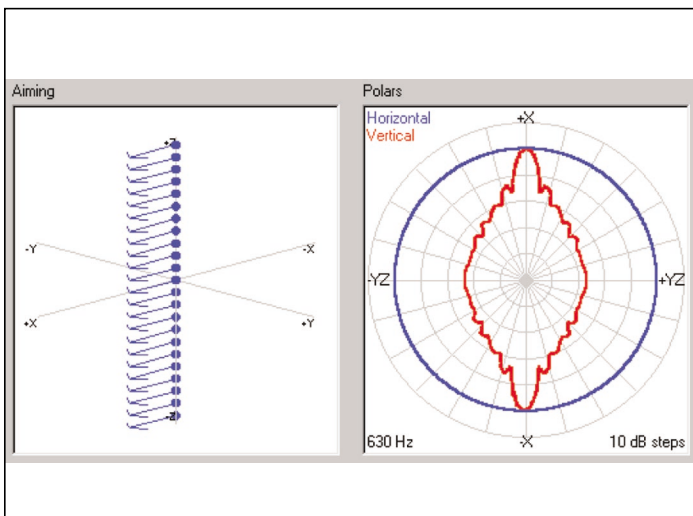

Figure 16

Figure 17 is a key design consideration when designing a full bandwidth line array system. Practical line arrays not only require that the radiating elements separation "B" be less than the wave lengths radiated for those devices, but subsequent spacing of cabinets is also required to be very small compared to the wave-lengths.

In **Figure 18**, we see a linear arrangement of 8 cabinets. We have another spacing constant B' that is required to be very small. In addition, the line array overall height H must be large compared to the radiated wavelengths. The device separation B and line array height H are two key parameters to describe both the high frequency limits (fmax) and low frequency limits (fmin) of a line array system. The space B helps to determine Fmax, the highest frequency of well-behaved summing. The parameter H defines Fmin, the lowest frequency that the line array can maintain a constant directivity versus frequency. As previously noted, the space in B' (the space between enclosures) must always be less than a wavelength. The array height

H must always be at least 4 to 5 times longer than the longest frequency of radiation to achieve constant directivity index versus frequency.

As we will see in subsequent discussions, these two parameters are the key parameters controlling our overall line array performance and its bandwidth. As can be seen from examination of the previous slides, physical orientations of radiating sources can produce improved directional response. The improvements in Q and associated directivity index gains are simply the result of the fact that the radiating sources (all of the same amplitude and phase) are separated physically in space and hence the arrival of signals at any given point in space are at different times and result in either constructive or destructive addition (peaks and dips in response).

The constructive addition, of course, is the desire of the system's designer and understanding the destructive addition (dips, or cancellation) is necessary in order to fully optimize the overall system's results. It has been seen that directional radiation can be achieved by orientation of simple sources.

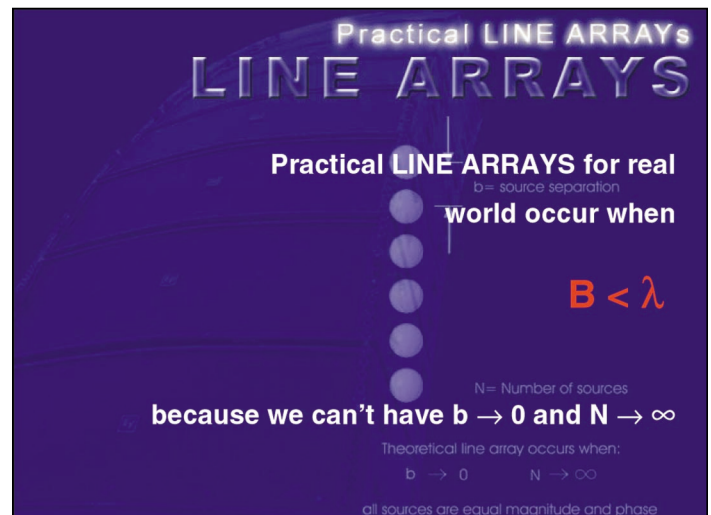

Figure 17

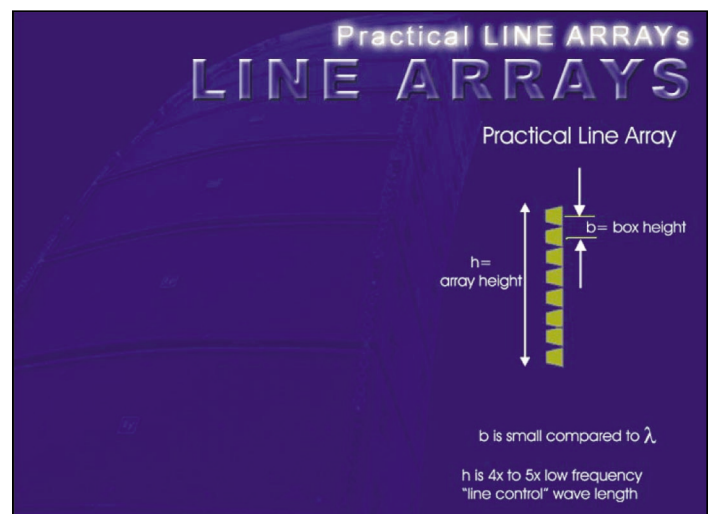

Figure 18

There is, of course, a second way to achieve direction radiation. That is through directional devices. The most universal directional device is a horn. **Figure 19** shows a single horn with radiating device (a compression driver) mounted to the back section of the horn. This small entrance, or throat, is coupled to the air via the length of the horn and the horn mouth.

Figure 20 shows three horns oriented in a vertical fashion. In this case, the minimum spacing achievable because of the dimensions of the horn themselves is 9.25 inches.

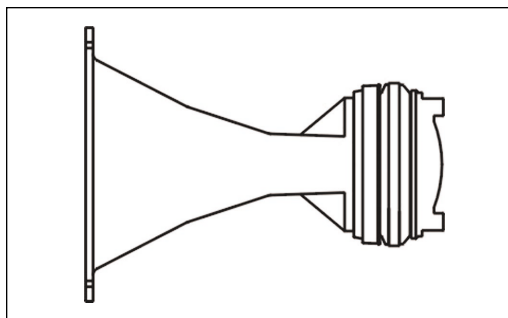

Figure 19

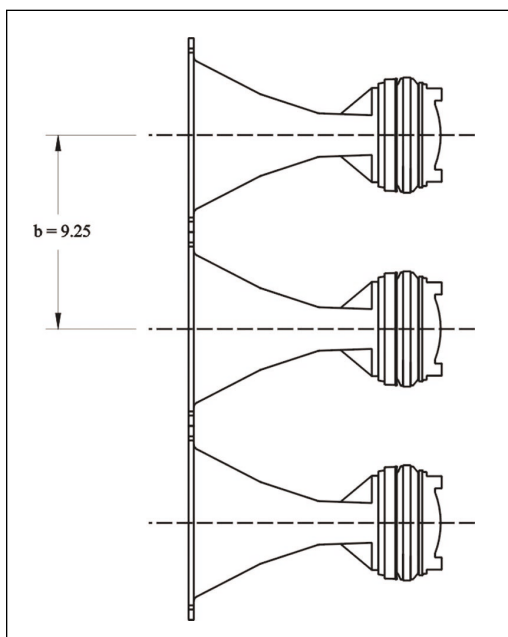

Figure 20

Figure 21 is a polar presentation of the radiation from those 3 vertically oriented high-frequency horns at 5,000 Hz. This frequency was chosen because it is small compared to the device spacing and the associated vertical polar pattern shown in this figure should be familiar to anyone who's ever tried to make vertical stacks of high frequency horns in an attempt to improve the directional radiation. Although the radiation is certainly improved (the Q is increased and as a consequence there is more gain on the major axis), examination of the figure shows substantial polar lobing error (i.e. nulls of up to 15 dB from the on axis reference). This vertical orientation of devices, although producing an improved directivity index, would suffer

from substantial lobing errors as one walks from the +x axis to the -y (that is, walk from the front of the array toward the back of a venue covering the entire included vertical angle of the venue).

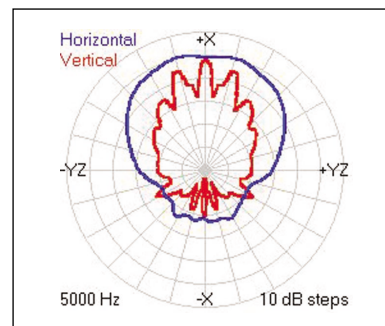

Figure 21

Figure 22 shows an Array Show plot of a point source and compares it to the Array Show plot of the directional improvements in response associated with the application of the horn. It can be seen that the directivity of the devices is indeed improved, but as noted in the previous figure, an attempt to generate a continuous line source of the devices is limited by the physical dictates of the device dimensions. Again, in this case, a 9.25 inch spacing is as close as they can be physically positioned which limits Fmax for the highest frequency of acceptable summing to below 2 kHz. Nevertheless, horns are very useful devices and basically perform two functions.

The first function is that of "directing" wave fronts that are comparable to or shorter than the horn dimensions in a given area. This is achieved simply by virtue of the sides and top and bottom walls of the horn. Again, it should be reinforced, the horn is only capable of this control of radiation where the wavelengths are comparable or shorter than the dimensions of the horn itself, (that is, for high frequencies, as defined earlier in this paper.)

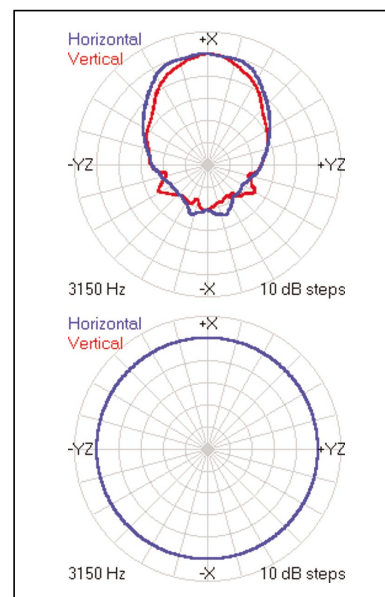

Figure 22

The second function of the horn is that of an acoustic transformer. **Figure 23, Equation 3**, represents how the acoustic transformer is physically realized in a horn. The diaphragm radiating the energy has an area v_d and an area a_d . That radiated energy is transmitted into the small section, or throat, of the horn. The velocity of air in that throat is represented by v_t and the area of the throat is represented by a_t . Conservation principles require that:

Figure 23, Equation 3

$$V_D A_D = V_T A_T$$

Let $V_D = 4 \text{ in/sec}$
 $A_D = 4 \text{ in}^2$
 $A_T = 1 \text{ in}^2$
 $V_D A_D = V_T A_T$
 $(4)(4) = V_T (1)$
 $V_T = 16 \text{ in/sec}$

Where $V_D = \text{velocity of diaphragm}$
 $A_D = \text{area of diaphragm}$
 $V_T = \text{velocity in throat}$
 $A_T = \text{area of throat}$

A simple example is shown in **Figure 23, Equation 3** where we arbitrarily set v_d to 4 inches per second and the area of the diaphragm is arbitrarily set to 4 square inches (these are thoroughly arbitrarily quantities simply selected to make the arithmetic very simple). We now arbitrarily set the area of the throat to 1. This is where the term compression driver comes from, as the area of the radiating diaphragm is many times greater than the area of the throat. The air displaced by the diaphragm then encounters a substantially reduced area in the throat. The air is compressed and the diaphragm is able to “do more work” against the air in the throat. In the example here using the arbitrary parameters, the equation becomes as shown. Solving for v_t generates 16 inches per second, a substantial gain over the physical velocity of the diaphragm itself. In this case we have the velocity in the throat substantially greater than the velocity of the diaphragm, and we generate an additional conversion efficiency as a result.

We have now illustrated two methods of achieving directional radiation, that of orientation of simple sources or of coupling a horn to a radiating source. An important concept at this point is to introduce the product theorem.

Figure 24, Equation 4

$$P(r, \theta, \phi) = P_{AX}(r) | H(\theta, \phi) H(\theta, \phi) |$$

Where $H(\theta, \phi)$ is the expression that describes the directional characteristics of each source.

The product theorem is shown in **Figure 24, Equation 4**. The explanation of this equation is very simple and again, is a key to our physical realization of an effective line array. The product theorem simply says that a simple source array has a multiplying factor that is described by the directional nature or “Q” of each horn loaded element. Or put another way, the result of a nonsimple array equals the simple array directionality plus the individual device directionality.

Figures 25 and 26 illustrate this very graphically. **Figure 26** should be familiar. It, again, is the a long vertical arrangement of simple point sources each spaced 12 inches apart. The frequency is 630 Hz and, again, is relatively long compared to the device spacing (in this case, the wavelength is 2 times the device spacing). Comparison of this polar with the same array where the simple sources have been replaced with horns, each bringing their own directionality, shows the change in vertical radiation. Substantially higher Q and associated higher directivity index are the result of the combination of the directionality of the array with the simple sources and a multiplier of that directivity that is the directionality of each horn device that has replaced the simple radiating source.

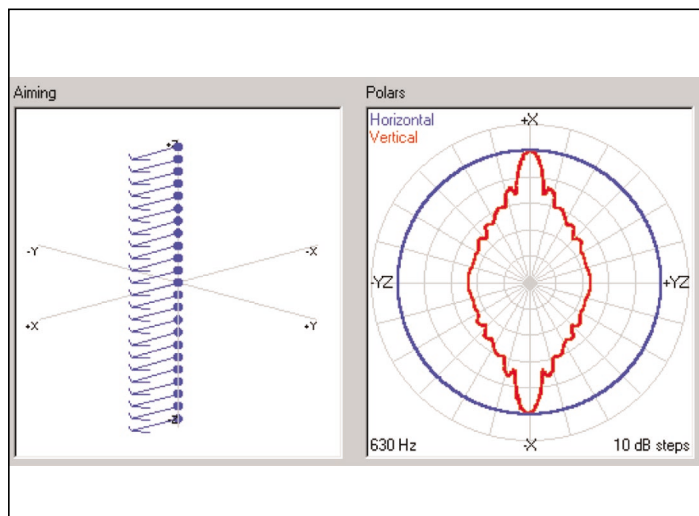

Figure 25

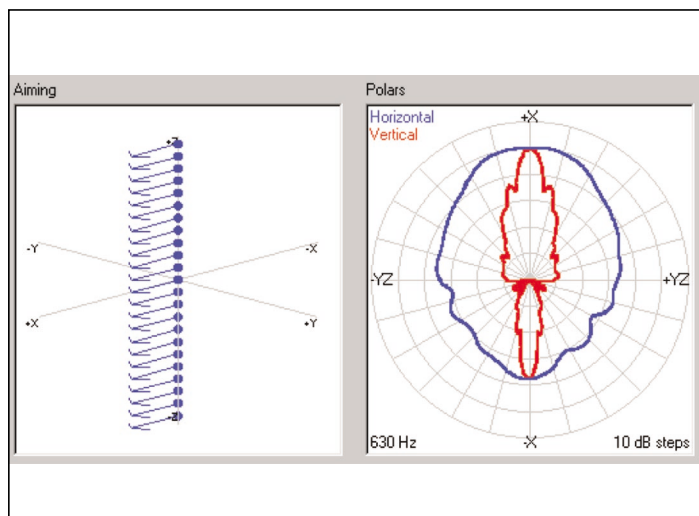

Figure 26

Realizing a Full Bandwidth Line Array

Full bandwidth line arrays are typically three way systems. The practice of dividing the band into 3 separate passes is done to enable the cross-over points to always be substantially low enough that the radiation from each pass exhibits wavelengths that are always longer than the physical device, or driver spacing. This is relatively easy to achieve for the low frequency section of any line array and is also easy to achieve for the mid-band section.

In mid-band sections the mid range devices are 6 inches in diameter to 8 inches in diameter. The crossover points are selected so that the device spacing is always small compared to the wavelength radiated. The problem for a full bandwidth line array systems is the high frequency radiation.

As mentioned earlier, historical line arrays were excellent in terms of low frequency and mid-band control of the pattern, but always suffered from polar lobing errors associated with the device space "B" being greater than the wavelengths being radiated. A 16 kHz wavelength is on the order of 3/4 of an inch and as a consequence device spacing must be comparable to those wavelengths or shorter, if possible. This was always a problem in the past because engineering techniques could not realize spacing closer than the driver diameters themselves. Even with modern neodymium iron boron based magnetics, the diameters were always at least 4 inches or greater (for large format diaphragm devices). That spacing limited good performance to below approximately 3 kHz, obviously not a full bandwidth device.

As a practical example, f_{max} , the maximum high frequency control based on the relationship between the spacing of the devices b and the wavelengths is as follows. For base line arrays where we are interested in control up to 250 hz, the spacing needs to be at least 4.5 feet. This is relatively easy to do with 15 inch and 12 inch drivers and as a result the realization of bass frequency line arrays is very straightforward.

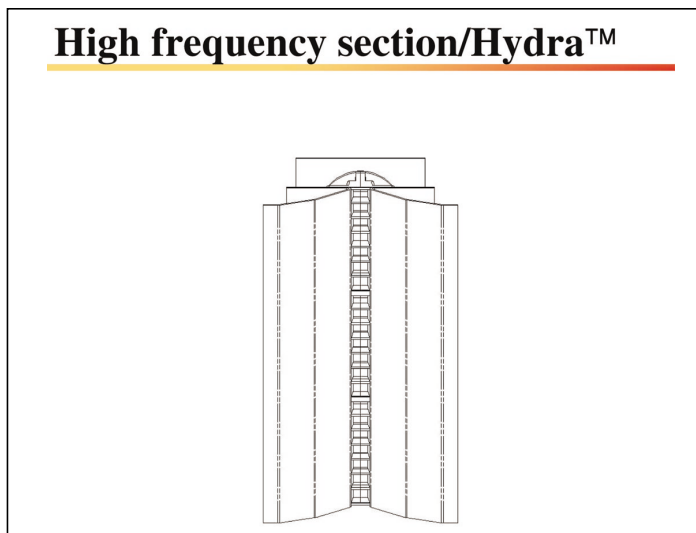

Figure 27

For mid-band line arrays, if we are interested in frequencies between 250 and 1,250 hz, the spacing needs to be 11 inches or smaller. Again, this is relatively easy to do with 6 inch or 8-inch drivers, and this is frequently the diameter of mid range devices in both large format and compact line array systems.

Figure 27 shows an Electro Voice Hydra™. This device basically takes the radiation of a compression driver and acts to produce both equal amplitude and equal phase sources at the front of the wave-guide. The full drawing in **Figure 27** is 3 Hydras vertically stacked, thereby generating 21 "point source" radiating surfaces coupled to a horizontal wave guide with an included angle varying between 90 and 120 (model dependent).

Figure 28 shows a Hydra without the driver or wave-guide coupled. Each hydra has 7 output "slots". The driver is coupled to the input side of the hydra and the 7 outputs are then interfaced with a horizontal wave-guide to produce the required horizontal included angle. The space b for a hydra is .826 inches, which equates to a wavelength of 16,434 Hz. Again, it is always best for wavelengths to be longer than that spacing, so in this implementation, the Hydra presents excellent high frequency control in the 15kHz to 16 kHz range. The Array Show plot **Figure 29** shows 21-point sources in a vertical orientation with the exact spacing provided by a hydra.

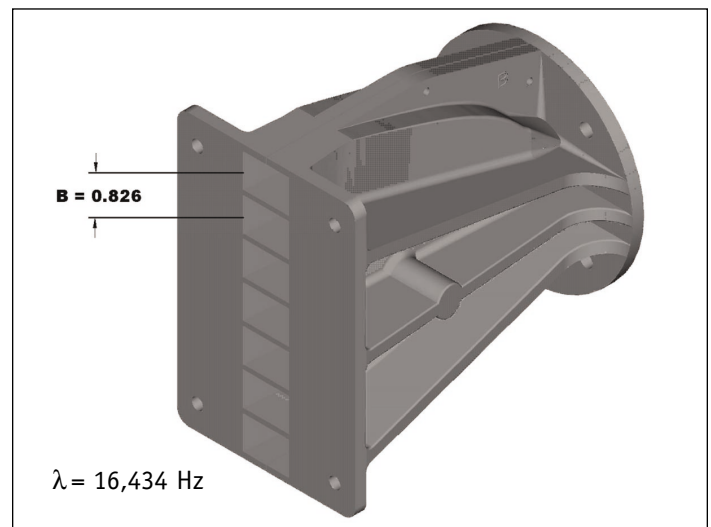

Figure 28

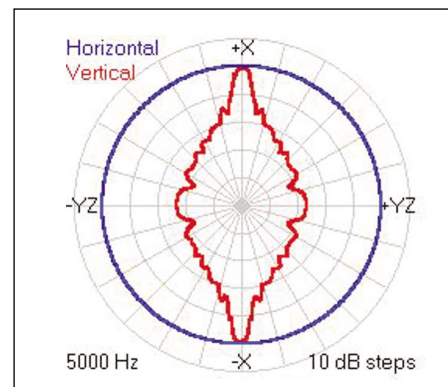

Figure 29

Realized Line Arrays/Horizontal Geometry

Figure 30 represents two possible methods of orienting a full bandwidth line array. The two methods are axis symmetric and axis asymmetric. The most common realization is that of an axis symmetric. It is the left hand drawing on **Figure 30**. The high frequency section is in the horizontal center of the enclosure and is flanked by two mid drivers of 6 to 8 inch diameter and two low frequency drivers of 12 inch to 15-inch diameter (depending on individual realization).

One of the advantages of an axis symmetric design is that horizontal response is the same either side of the center axis.

Figure 31 shows a close up of an axis symmetric design. Of course one of the consequences for axis symmetry is that devices now become horizontal “arrays”. For most of this paper we’ve focused our discussions on vertical orientation of arrays, but it should be remembered that the same directional response characteristics exist for devices whether they are oriented vertically or horizontally.

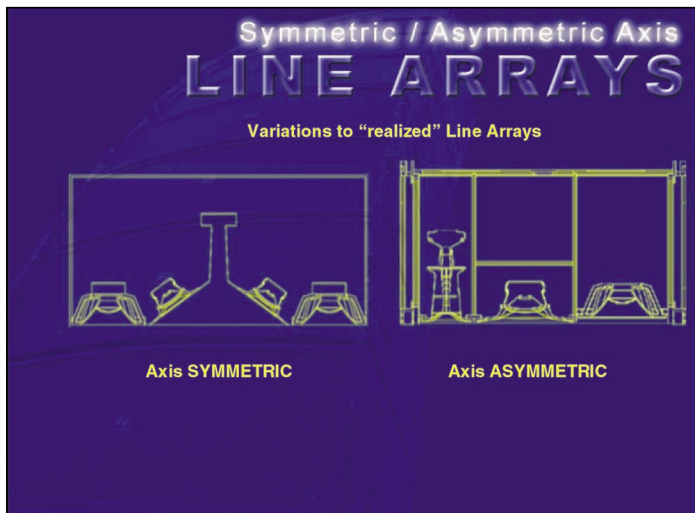

Figure 30

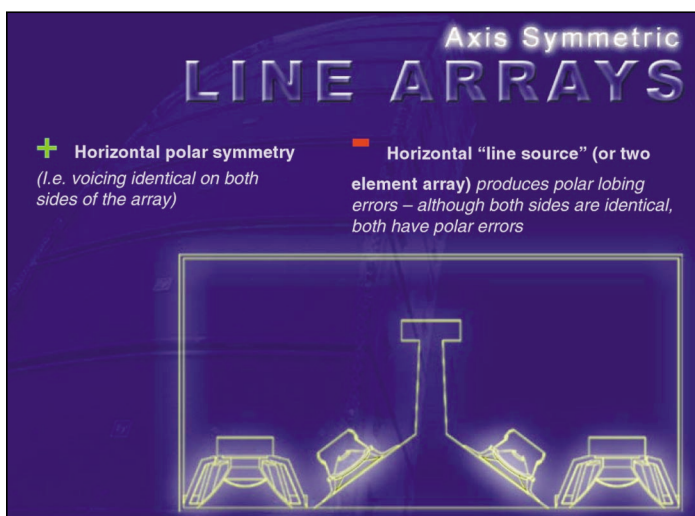

Figure 31

There is a common mistake in sound reinforcement practice for people who normally understand that stacking devices vertically will control the vertical pattern to then stack devices horizontally in the misguided attempt to increase the horizontal radiation pattern. This is something termed array arithmetic. In normal arithmetic, $40 + 40 + 40$ will always equal 120. This, unfortunately, is not always the case with acoustics. In the same example, three enclosures stacked horizontally are usually done so because the array designer or the person developing the array has a desire to cover an included angle of 120 degrees (an example). The three 40 degree devices stacked horizontally will add to 120 degrees under certain conditions. They will also add to 20 degrees when the wavelengths are comparable to the spacing between the devices. This, again, takes us back to the exact discussions we’ve seen earlier in this paper with regards to vertical stacking. It should be remembered by all designers that stacking, whether the arrays are horizontal or vertical, will always narrow the pattern in the axis that the devices are oriented. This brings us back to the mid range devices and low frequency devices in an axis symmetric design. These axis symmetric designs are small horizontal arrays.

Figure 32 shows two eight inch drivers separated by a one-inch exit vertical slot for high frequency radiation. The two mid devices are oriented into a 90 degree included angle, but this spacing results in a horizontal array that exhibits the polar performance illustrated in **Figure 33**. When a cross over frequency of 1250 Hz is used, the response is basically 6 dB down at 30 degrees off axis generating an included angle of 60 degrees, not the 90 degrees desired by the designer of the product. This is the result of the classic “horizontal array” and will always occur when the crossover point is comparable to the device spacing. This, of course, can be eliminated by taking the crossover frequency substantially lower. Unfortunately, compression driver performance, in terms of mechanically generated distortion products and device reliability are severely compromised in the 700 to 800 region that is required for this type of device spacing. This is a classic trade-off seen often in acoustics where one parameter is optimized at the expense of a second parameter.

In this case, to achieve proper horizontal radiation and the desired included angle, the distortion, fidelity and reliability of the compression drivers are compromised; in order to produce proper fidelity, polar response is compromised.

An alternate approach is the axis asymmetric design also shown in **Figure 30**. In this design, there are no horizontal arrays. The trade-off, of course, is that the device voicing is not the same on the left hand side of the system as the right hand side. This, however, can be seen as a minor trade-off because the horizontal pattern is substantially improved and as a result, stereo imaging is enhanced. It has often been argued

that the asymmetrical voicing produced by the axis asymmetric design is a design compromise but it can be seen as less of a compromise than that of the axis symmetric where the pattern begins to narrow or the sonic performance of the drivers is compromised because of using too low of a crossover frequency.

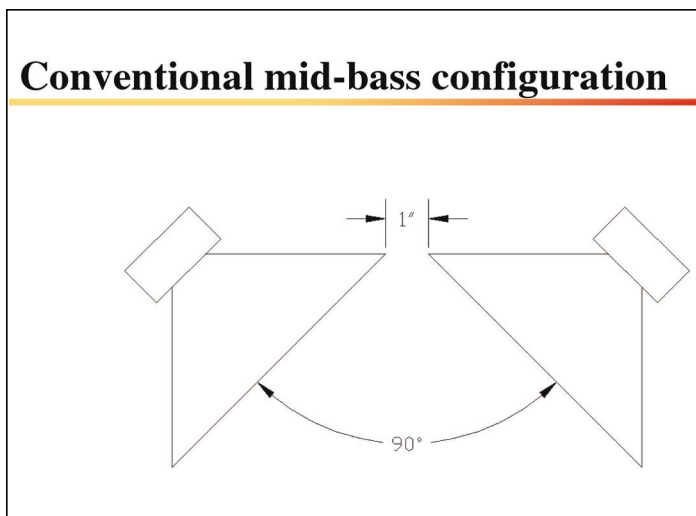

Figure 32

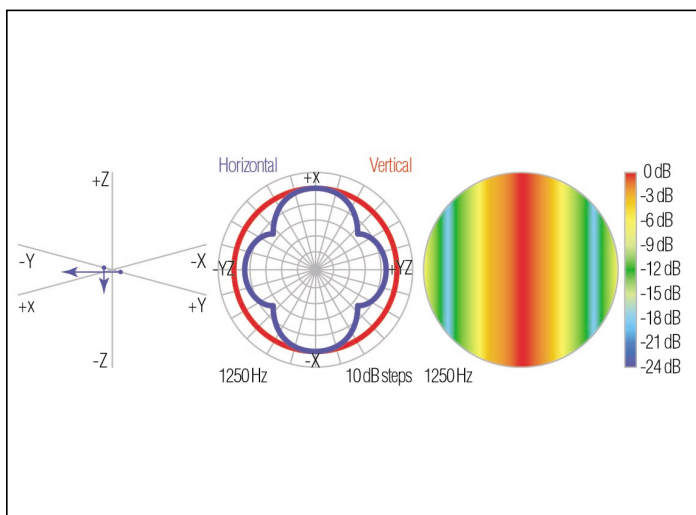

Figure 33

The second important parameter in line array design is that of the minimum control frequency. We've discussed f_{max} , the high frequency control that is limited largely by the spacing b between devices. Discussion of f_{min} is also appropriate. The low frequency control of the line array is dictated by the physical height h of the array itself in **Figure 34, Equation 5**. This is very analogous to the low frequency control of the conventional horn related to its mouth height. **Figure 34, Equation 5** shows that f_{min} equals a constant over the product of the required included angle and the height. As can be seen, f_{min} with a horn is related or is proportional to its overall height. This is exactly the case for f_{min} with a vertical orientation of sources, or a line array.

Figure 34, Equation 5

$$f_{min} = \frac{K}{(\text{included angle}) (h)}$$

Figure 35 shows the low frequency performance of a line array related to its overall height. It shows both a multiple of 4 and a multiple of 5. This could be easily misconstrued that the number of boxes controls the low frequency cut-off. This is only indirectly the case. The actual parameter is the physical height of the array, so large format, concert level line arrays like the EV X-Line certainly require less boxes to get to a particular cut-off frequency. The important thing to note from **Figure 35** is that if we average the 4 multiplier and 5 multiplier, we see that a four box system in the case of a compact line array (the XLC from Electro Voice) is limited to a 1,000 hz control frequency, which relates to an overall line height of 58 inches. Frequently line arrays are presented that are 20 or 30 inches tall. These are certainly line arrays from a high frequency standpoint, if the criteria is achieved to produce a full bandwidth f_{max} . Their ability to control the polar pattern at low frequencies, however, is limited by their height. To achieve a 300 hz low frequency intercept, or f_{min} , the overall height of the line array system needs to be roughly 203 inches. **Figure 35** is very instructive in terms of designing line arrays to low frequency control limits.

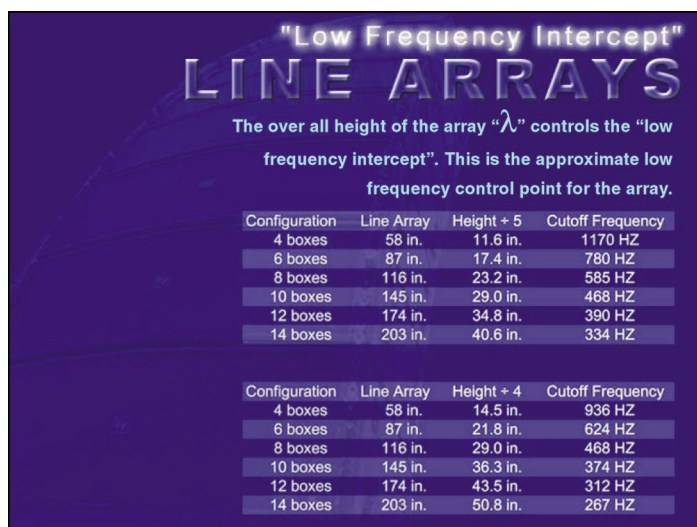

Figure 35

An alternate way of looking at this chart and looking at this parameter is seen in **Figure 36**. This shows the beamwidth versus the frequency for a 58-inch high line array and a 116 high line array, doubling the height, as one would expect, reduces, or improves the control by one octave. It is also interesting to note that if one desires a 150 Hz line array control, the line array must be 406 inches tall (almost 34 feet tall), which certainly is taller than typical line array systems.

It illustrates the same point that people are used to seeing with basic horns, that is, the lower the frequency of control, the larger the mouth must be.

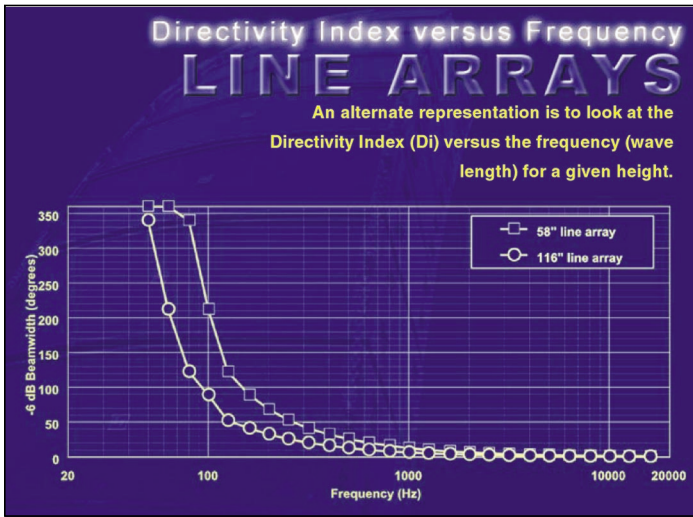

Figure 36

Line Array Performance and General Geometry

The vertical profile of a line array can either be symmetrical or asymmetrical. What is meant by that is that you can either have a straight-line array or a curved section but symmetry still exists about the center axis of the system. The sharpest beam width will occur for flat or linear line arrays. The higher the number of sources (n) the more the polar lobing errors are minimized. This condition occurs independent of the physical realization or design of the line array itself, and is purely related to the number of radiating surfaces. Symmetrical curved arrays broaden the beam width as compared to flat arrays. The more the curve (the less the radius), the broader the beamwidth. The third type of profile is that of an asymmetric design. This is typically the case where there is a curved or flat section on the top of the array and a more curved or (j) section at the bottom. The result of this j is to further increase the included vertical angle of the system, but also to tilt the major lobe. This tilt is accomplished via the steering properties of the asymmetrical portion of the array.

Figure 37 shows the vertical lobe generated from a perfectly flat (or standard linear) line array. It can be shown that the lobe is extremely sharp and it should always be remembered that the major lobe emanates from the vertical center of the system. Early applications of line arrays consisted of aiming the systems with a laser mounted on the top of the overall array. This is very inappropriate as can be seen from any of the figures (Figure 37, Figure 38 and Figure 39).

Regardless of the shape, whether flat, symmetrical, curved symmetrical, or asymmetrical, the major lobe always emanates from the physical center of the system and may be steered by the asymmetrical portion of the array, but generally continues to emanate from the center. Figure 38 shows a curved array,

and again, shows symmetry about the center axis of the array. Figure 39 is a classic J array, and examination will reveal a lobe very similar to that of Figure 38 with the addition of the increase in energy toward the bottom half of the array, where the j curve is steering the system. Figure 40 is an idealized representation of a flat or linear source, showing the center of the acoustic lobe emanating from the vertical center of the system. It also represents "old custom" of a laser mounted at the top and assuming the top box pointed at the back of the venue presented a major portion of the energy into that area.

As can be seen very quickly from the simple example the response with a proper line array is very high Q and the amplitude falls off very rapidly from either side of the center of the acoustic cube. This is desirable working below the center of the acoustic lobe, as proper aiming can, in fact, compensate for attenuation of sound with distance and produce remarkably even front to back coverage. That advantage becomes a disadvantage if the upper portion of the lobe is attempted to be used to cover the audience in the rear portion of the venue.

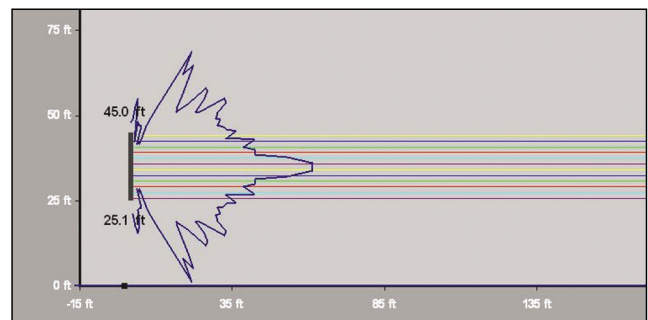

Figure 37

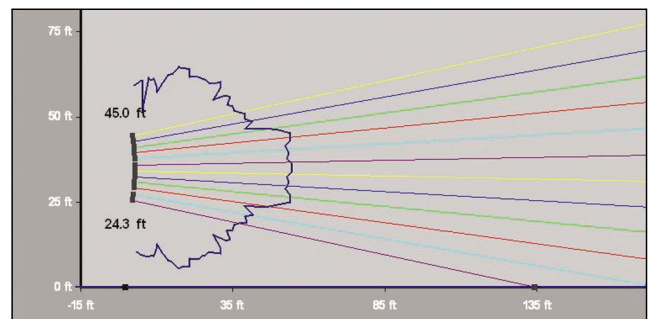

Figure 38

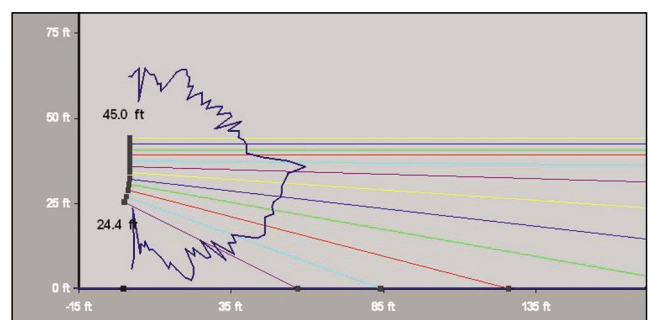

Figure 39

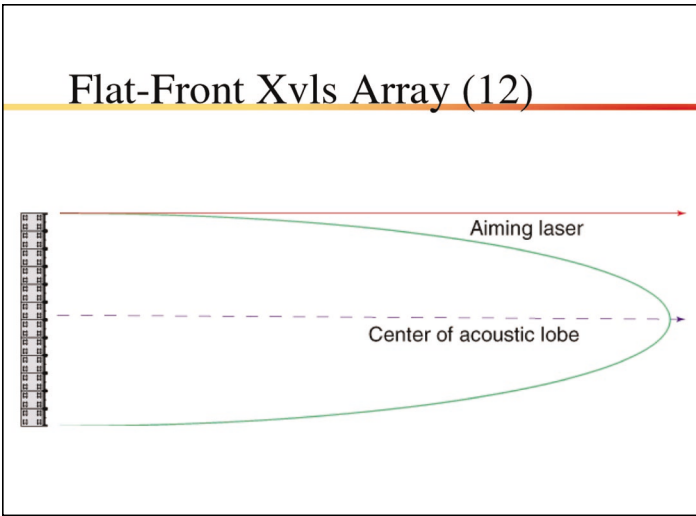

Figure 40

Line Arrays and Very Low Frequencies

Traditional practice with low frequency radiators, or subwoofers, has been to groundstack the subs. Groundstacking produces the familiar 3 db doubling of pressure, because of the conversion in the acoustic load from a 4π steradian to 2π steradian load. **Figure 41, Equation 6** and **Figure 42, Equation 7** show the change from full space to half space loading and the subsequent pressure doubling. The physical height requirements of a full band with line array, however, bring an important performance advantage to flying subs. While it is completely true that the pressure doubling is lost when the subs are removed from the floor, there is a substantial gain associated with a large vertical array of low frequency sources.

Figure 41, Equation 6

$$\text{Full space pressure } \rho \sim p.c \frac{QK}{4\pi r}$$

Figure 42, Equation 7

$$\text{Half space pressure } \rho^{1/2} \sim p.c \frac{QK}{2\pi r}$$

Figure 43 shows polar response of a 3 by 3 groundstack. The vertical control gained via not only the geometry of the stack itself, but because of the coherent reflection of the floor. A 12 high flown array is shown in **Figure 44**. Although the polar pattern is partly compromised, the Q is substantially increased. The associated gain in directivity index is a very valuable tool for a system designer. In **Figure 45** shows a typical groundstack. A 200-foot long room would exhibit the following performance. A flow line array would generate, if properly aimed, a +/- 1dB to 2 dB variation front to back in the venue described in the example. In that same situation, the groundstacked sub would exhibit a 24-1/2 db variation of

low frequency material from the front to the back. This is an obvious compromise in the full bandwidth control (or directivity index versus frequency control) of the system. With proper aiming, a 12 box high vertical line array of low frequency material can substantially improve the overall front to back SPL coverage of very low frequencies. Although this 12 box hang is nowhere near high enough to control 100 Hz and below, the improvement in uniformity of front to back is 5 to 10 times better than that of the groundstack. Because of that improvement in front to back uniformity, flying subs are highly recommended where improved full frequency coverage is required.

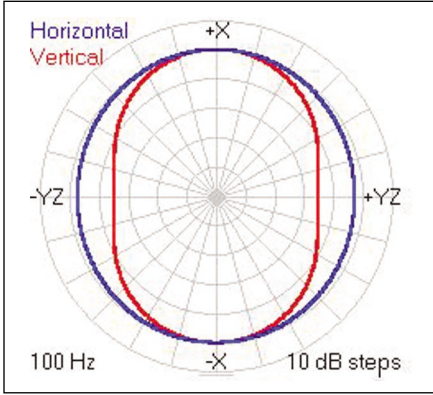

Figure 43

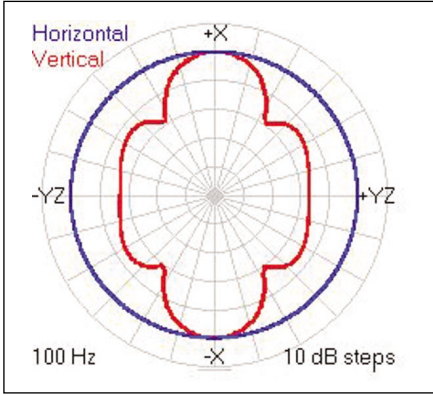

Figure 44

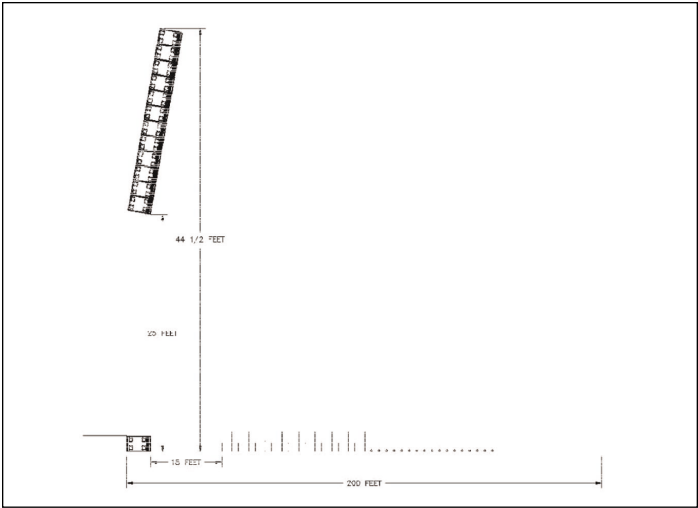

Figure 45

SUMMARY

Many claims have been made in recent years as to the “unique” performance characteristics of modern line array systems. The simple reality is that, for standard, curved or “j” arrays the performance is very well behaved because the device spacing and cabinet spacing are always small or comparable to the wavelengths being radiated. It is simple and straightforward. The attenuation of SPL is 6dB per every doubling of distance from the system (in the far field). That is exactly the behavior of a classical spherical radiating source. It is true that linear sources can exhibit a reduction of only 3dB for each doubling of distance but this occurs only in a limited section of the near to far field transition and is frequency dependent. What is more noteworthy is that this 3dB per doubling of distance behavior is only possible when the array geometry is perfectly flat. Initial line array users attempted to use flat arrays and always noted unacceptable included vertical angle performance (whether indoors or outdoors) and also noted extreme difficulty in matching the SPL coverage versus distance in the venue with the flat array’s major lobe (for curved arrays the near field

behavior is likely between 3dB and 6dB per doubling of distance and is very difficult to quantify).

It should also be noted that line arrays, although offering substantial benefits, are not suited for all applications. A line array needs proper aiming or substandard performance will result. Line arrays are not suited for low ceiling venues or venues that don’t generally match the included horizontal angle of the system. Conventional “cell arrays” of high Q elements, although suffering from all of the polar lobing errors noted in this paper, are often a better overall solution for low ceiling environments or long and narrow rooms.

Any attempts to use line arrays without good “application specific” aiming software can result in more frustration than success. Many manufacturers offer good line array CAD routines that will enable an educated user to achieve excellent results.

An additional advantage of aiming software is that it can be an excellent educational tool. A novice user can quickly work through a large variety of line array geometry and venue styles and easily see all of the concepts discussed in the paper come into practice.