

EVOLVE Portable Column Loudspeaker

EVOLVE50-TB, EVOLVE50-TW, EVOLVE50-SB, EVOLVE50-SW,
EVOLVE50-PL-SB, EVOLVE50-PL-SW

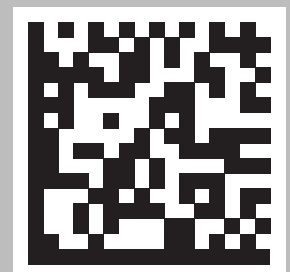
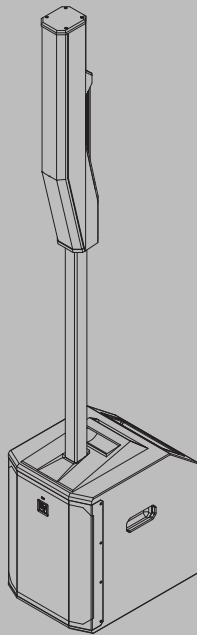





Table of contents

1	Safety	4
1.1	Important safety instructions	4
1.2	FCC information	5
1.3	Simplified Declaration of Conformity (sDoC)	6
1.4	Precautions	8
1.5	Certifications	9
1.6	Notices	10
2	Short information	12
2.1	Shipping contents	12
3	Description	14
3.1	System features	14
3.2	Quick setup	15
4	Installation	16
5	Amplifier DSP	17
5.1	Amplifier DSP controls	17
5.2	System status	18
5.3	DSP control menu	19
6	Pairing the QuickSmart Mobile application	26
7	Recommended configurations	27
7.1	Stereo pair of EVOLVE 50 systems	27
7.2	Solo musician performance	28
8	Troubleshooting	29
9	Technical data	31
9.1	Dimensions	32
9.2	Frequency response	33

1 Safety

1.1 Important safety instructions

 <p>WARNING: TO REDUCE THE RISK OF FIRE OR ELECTRIC SHOCK, DO NOT OVEREXPOSE THIS APPLIANCE TO RAIN OR MOISTURE</p> <p>AVIS: RISQUE DE CHOC ELECTRIQUE, NE PAS OUVRIR.</p> <p>WARNING: THE MAINS PLUG OR AC INLET IS USED AS A DISCONNECT DEVICE. THE DISCONNECT DEVICE SHALL REMAIN READILY OPERABLE.</p> <p>WARNING: CONNECT ONLY TO MAINS SOCKET WITH PROTECTIVE EARTHING CONNECTION.</p> <p>WARNING: TO REDUCE THE RISK OF ELECTRIC SHOCK, DO NOT REMOVE COVER (OR BACK) AS THERE ARE NO USER-SERVICABLE PARTS INSIDE. REFER SERVICING TO QUALIFIED PERSONNEL.</p>		<p>The lightning flash with arrowhead symbol, within an equilateral triangle is intended to alert the user to the presence of uninsulated “dangerous voltage” within the product’s enclosure that may be sufficient magnitude to constitute a risk of electric shock to persons.</p>
		<p>The exclamation point within an equilateral triangle is intended to alert the user to the presence of important operating and maintenance (servicing) instructions in the literature accompanying the appliance.</p>
		<p>The asterisk within an equilateral triangle is intended to inform the user to necessary installation or removal instructions regarding equipment or hardware use relating to the system.</p>

1. Read these instructions.
2. Keep these instructions.
3. Heed all warnings.
4. Follow all instructions.
5. Do not use this apparatus near water.
6. Clean only with a dry cloth.
7. Do not block any ventilation openings. Install in accordance with the manufacturer's instructions.
8. Do not install near any heat sources such as radiators, heat registers, stoves, or other apparatus (including amplifiers) that produce heat.
9. Do not defeat the safety purpose of the polarized or grounding-type plug. A polarized plug has two blades with one wider than the other. A grounding type plug has two blades and a third grounding prong. The wide blade or the third prong is provided for your safety. If the provided plug does not fit into your outlet, consult an electrician for replacement of the obsolete outlet.
10. Protect the power cord from being walked on or pinched particularly at plugs, convenience receptacles, and the point where they exit from the apparatus.
11. Only use attachments/accessories specified by the manufacturer.
12. Use only with the cart, stand, tripod, bracket, or table specified by the manufacturer, or with the apparatus. When a cart is used, use caution when moving the cart/apparatus combination to avoid injury from tip-over.
13. Unplug the apparatus during lightning storms or when unused for long periods of time.

14. Refer all servicing to qualified service personnel. Servicing is required when the apparatus has been damaged in any way, such as power-supply cord or plug is damaged, liquid has been spilled or objects have fallen into the apparatus, the apparatus has been exposed to rain or moisture, does not operate normally, or has been dropped.
15. No naked flame sources, such as lighted candles, should be placed on the apparatus.
16. To reduce the risk of fire or electric shock, do not expose this apparatus to rain or moisture. The apparatus should not be exposed to dripping or splashing. Objects filled with liquids, such as vases should not be placed on apparatus.
17. Do not block any ventilation openings. Install in accordance with the manufacturer's instructions.
18. Minimum 60 cm (2 ft) distances around the apparatus for sufficient ventilation.
19. The ventilation should not be impeded by covering the ventilation openings with items, such as newspapers, table-cloths, curtains, etc.
20. To completely disconnect AC power from this apparatus, the power supply cord must be unplugged.

**Warning!**

This product is designed ONLY to be suspended with authorized Electro-Voice mounting accessories. Do NOT use non-authorized brackets or methods to suspend the loudspeaker. Handles on Electro-Voice loudspeakers are intended to only be used for temporary transport by people or for use with Electro-Voice authorized mounting accessories ONLY. Items such as fiber rope, wire rope, cables, or other types of materials cannot be used to suspend the loudspeaker from the handles.

**Caution!**

Do not attempt to move this loudspeaker system when it is fully assembled. You may damage the system or cause personal injury.

1.2

FCC information

This device complies with Part 15 of the FCC Rules. Operation is subject to the following two conditions:

- (1) This device may not cause harmful interference, and
- (2) This device must accept any interference received, including interference that may cause undesired operation.

**Notice!**

This product has been tested and found to comply with the limits for a Class B digital device, pursuant to Part 15 of the FCC Rules. These limits are designed to provide reasonable protection against harmful interference in a residential installation. This product generates, uses, and can radiate radio frequency energy and, if not installed and used in accordance with the instructions, may cause harmful interference to radio communications.

However, there is no guarantee that interference will not occur in a particular installation. If this product does cause harmful interference to radio or television reception, which can be determined by turning the equipment off and on, the user is encouraged to try to correct the interference by one or more of the following measures:

- Reorient or relocate the receiving antenna.
- Increase the separation between the equipment and receiver.
- Connect the equipment into an outlet on a circuit different from that to which the receiver is connected.
- Consult the dealer or an experienced radio/TV technician for help.

The device contains a BT module CYBLE-022001-00 which has been granted by FCC and IC, the FCC ID:WAP2001 and IC:7922A-2001. And module is assembled on the PRE PCB

Please take attention that changes or modification not expressly approved by the party responsible for compliance could void the user's authority to operate the equipment.

This equipment should be installed and operated with a minimum distance 20cm between the radiator and your body

This device complies with Industry Canada license-exempt RSS standard(s). Operation is subject to the following two conditions:

- (1) this device may not cause interference, and
- (2) this device must accept any interference, including interference that may cause undesired operation of the device.

Le présent appareil est conforme aux CNR d'Industrie Canada applicables aux appareils radioexempts de licence. L'exploitation est autorisée aux deux conditions suivantes :

- (1) l'appareil ne doit pas produire de brouillage, et
- (2) l'utilisateur de l'appareil doit accepter tout brouillage radioélectrique subi, même si le brouillage est susceptible d'en compromettre le fonctionnement.

Under Industry Canada regulations, this radio transmitter may only operate using an antenna of a type and maximum (or lesser) gain approved for the transmitter by Industry Canada. To reduce potential radio interference to other users, the antenna type and its gain should be so chosen that the equivalent isotropically radiated power (e.i.r.p.) is not more than that necessary for successful communication.

Conformément à la réglementation d'Industrie Canada, le présent émetteur radio peut fonctionner avec une antenne d'un type et d'un gain maximal (ou inférieur) approuvé pour l'émetteur par Industrie Canada. Dans le but de réduire les risques de brouillage radioélectrique à l'intention des autres utilisateurs, il faut choisir le type d'antenne et son gain de sorte que la puissance isotrope rayonnée équivalente (p.i.r.e.) ne dépasse pas l'intensité nécessaire à l'établissement d'une communication satisfaisante.

1.3

Simplified Declaration of Conformity (sDoC)



BG	С настоящото Bosch Security Systems, LLC декларира, че този тип радиосъоръжение EVOLVE 50-SB-EU, EVOLVE 50-SW е в съответствие с Директива 2014/53/ЕС. Цялостният текст на ЕС декларацията за съответствие може да се намери на следния интернет адрес: www.electrovoice.com
CS	Tímto Bosch Security Systems, LLC prohlašuje, že typ rádiového zařízení EVOLVE 50-SB-EU, EVOLVE 50-SW je v souladu se směrnicí 2014/53/EU. Úplné znění EU prohlášení o shodě je k dispozici na této internetové adrese: www.electrovoice.com
DA	Hermed erklærer Bosch Security Systems, LLC, at radioudstyrstypen EVOLVE 50-SB-EU, EVOLVE 50-SW er i overensstemmelse med direktiv 2014/53/EU. EU-overensstemmelseserklæringens fulde tekst kan findes på følgende internetadresse: www.electrovoice.com

DE	Hiermit erklärt Bosch Security Systems, LLC , dass der Funkanlagentyp EVOLVE 50-SB-EU, EVOLVE 50-SW der Richtlinie 2014/53/EU entspricht. Der vollständige Text der EU-Konformitätserklärung ist unter der folgenden Internetadresse verfügbar: www.electrovoice.com
EL	Με την παρούσα ο/η Bosch Security Systems, LLC , δηλώνει ότι ο ραδιοεξοπλισμός EVOLVE 50-SB-EU, EVOLVE 50-SW πληροί την οδηγία 2014/53/EE. Το πλήρες κείμενο της δήλωσης συμμόρφωσης ΕΕ διατίθεται στην ακόλουθη ιστοσελίδα στο διαδίκτυο: www.electrovoice.com
EN	Hereby, Bosch Security Systems, LLC declares that the radio equipment type EVOLVE 50-SB-EU, EVOLVE 50-SW is in compliance with Directive 2014/53/EU and the relevant statutory requirements. The full text of the EU declaration of conformity and the UK declaration of conformity are available at the following internet address: www.electrovoice.com
ES	Por la presente, Bosch Security Systems, LLC declara que el tipo de equipo radioeléctrico EVOLVE 50-SB-EU, EVOLVE 50-SW es conforme con la Directiva 2014/53/UE. El texto completo de la declaración UE de conformidad está disponible en la dirección Internet siguiente: www.electrovoice.com
ET	Käesolevaga deklareerib Bosch Security Systems, LLC , et käesolev raadioseadme tüüp EVOLVE 50-SB-EU, EVOLVE 50-SW vastab direktiivi 2014/53/EL nõuetele. ELi vastavusdeklaratsiooni täielik tekst on kättesaadav järgmisel internetiaadressil: www.electrovoice.com
FI	Bosch Security Systems, LLC vakuuttaa, että radiolaitetyypit EVOLVE 50-SB-EU, EVOLVE 50-SW on direktiivin 2014/53/EU mukainen. EU-vaatimustenmukaisuusvakuutuksen täysimittainen teksti on saatavilla seuraavassa internetosoitteessa: www.electrovoice.com
FR	Le soussigné, Bosch Security Systems, LLC , déclare que l'équipement radioélectrique du type EVOLVE 50-SB-EU, EVOLVE 50-SW est conforme à la directive 2014/53/UE. Le texte complet de la déclaration UE de conformité est disponible à l'adresse internet suivante: www.electrovoice.com
HR	Bosch Security Systems, LLC ovime izjavljuje da je radijska oprema tipa EVOLVE 50-SB-EU, EVOLVE 50-SW u skladu s Direktivom 2014/53/EU. Cjeloviti tekst EU izjave o sukladnosti dostupan je na sljedećoj internetskoj adresi: www.electrovoice.com
HU	Bosch Security Systems, LLC igazolja, hogy a EVOLVE 50-SB-EU, EVOLVE 50-SW típusú rádióberendezés megfelel a 2014/53/EU irányelvnek. Az EU-megfelelőségi nyilatkozat teljes szövege elérhető a következő internetes címen: www.electrovoice.com
IT	Il fabbricante, Bosch Security Systems, LLC , dichiara che il tipo di apparecchiatura radio EVOLVE 50-SB-EU, EVOLVE 50-SW è conforme alla direttiva 2014/53/UE. Il testo completo della dichiarazione di conformità UE è disponibile al seguente indirizzo Internet: www.electrovoice.com
LT	Aš, Bosch Security Systems, LLC , patvirtinu, kad radijo įrenginių tipas EVOLVE 50-SB-EU, EVOLVE 50-SW atitinka Direktyvą 2014/53/ES. Visas ES atitikties deklaracijos tekstas prieinamas šiuo interneto adresu: www.electrovoice.com
LV	Ar šo Bosch Security Systems, LLC deklarē, ka radioiekārta EVOLVE 50-SB-EU, EVOLVE 50-SW atbilst Direktīvai 2014/53/ES. Pilns ES atbilstības deklarācijas teksts ir pieejams šādā interneta vietnē: www.electrovoice.com

MT	B'dan, Bosch Security Systems, LLC , niddikjara li dan it-tip ta' tagħmir tar-radju EVOLVE 50-SB-EU, EVOLVE 50-SW huwa konformi mad-Direttiva 2014/53/UE. It-test kollu tad-dikjarazzjoni ta' konformità tal-UE huwa disponibbli f'dan l-indirizz tal-Internet li ġej: www.electrovoice.com
NL	Hierbij verklaar ik, Bosch Security Systems, LLC , dat het type radioapparatuur EVOLVE 50-SB-EU, EVOLVE 50-SW conform is met Richtlijn 2014/53/EU. De volledige tekst van de EU-conformiteitsverklaring kan worden geraadpleegd op het volgende internetadres: www.electrovoice.com
PL	Bosch Security Systems, LLC niniejszym oświadcza, że typ urządzenia radiowego EVOLVE 50-SB-EU, EVOLVE 50-SW jest zgodny z dyrektywą 2014/53/UE. Pełny tekst deklaracji zgodności UE jest dostępny pod następującym adresem internetowym: www.electrovoice.com
PT	O(a) abaixo assinado(a) Bosch Security Systems, LLC declara que o presente tipo de equipamento de rádio EVOLVE 50-SB-EU, EVOLVE 50-SW está em conformidade com a Diretiva 2014/53/UE. O texto integral da declaração de conformidade está disponível no seguinte endereço de Internet: www.electrovoice.com
RO	Prin prezenta, Bosch Security Systems, LLC declară că tipul de echipamente radio EVOLVE 50-SB-EU, EVOLVE 50-SW este în conformitate cu Directiva 2014/53/UE. Textul integral al declarației UE de conformitate este disponibil la următoarea adresă internet: www.electrovoice.com
SK	Bosch Security Systems, LLC týmto vyhlasuje, že rádiové zariadenie typu EVOLVE 50-SB-EU, EVOLVE 50-SW je v súlade so smernicou 2014/53/EÚ. Úplné EÚ vyhlásenie o zhode je k dispozícii na tejto internetovej adrese: www.electrovoice.com
SL	Bosch Security Systems, LLC potrjuje, da je tip radijske opreme EVOLVE 50-SB-EU, EVOLVE 50-SW skladen z Direktivo 2014/53/EU. Celotno besedilo izjave EU o skladnosti je na voljo na naslednjem spletnem naslovu: www.electrovoice.com
SV	Härmed försäkrar Bosch Security Systems, LLC att denna typ av radioutrustning EVOLVE 50-SB-EU, EVOLVE 50-SW överensstämmer med direktiv 2014/53/EU. Den fullständiga texten till EU-försäkran om överensstämmelse finns på följande webbadress: www.electrovoice.com

1.4

Precautions

	If an Electro-Voice loudspeaker is used outdoors on a sunny day, place the loudspeaker in a shaded or covered area. The loudspeaker amplifiers have protection circuits that temporarily shut the loudspeaker off when extremely high temperatures are reached. This can happen on hot days when the loudspeaker is in direct sunlight.
	Do not use Electro-Voice loudspeakers in an environment where temperatures are below 0°C (32°F) or exceed +35°C (95°F).
	Never expose an Electro-Voice loudspeaker to rain, water, or high moisture.

Dealer no.: DA45733/15

1.6

Notices

Old electrical and electronic equipment

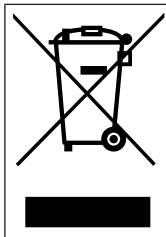

This product and/or battery must be disposed of separately from household waste. Dispose such equipment according to local laws and regulations, to allow their reuse and/or recycling. This will help in conserving resources, and in protecting human health and the environment.

Copyright and disclaimer

All rights reserved. No part of this document may be reproduced or transmitted in any form by any means, electronic, mechanical, photocopying, recording, or otherwise, without the prior written permission of the publisher. For information on getting permission for reprints and excerpts, contact Electro-Voice.

All content including specifications, data, and illustrations in this manual are subject to change without prior notice.



Notice!

Bluetooth® is available in select countries.

Contact your nearest Electro-Voice dealer or Electro-Voice distributor for more information.

The Bluetooth® word mark and logos are registered trademarks owned by Bluetooth SIG, Inc. and any use of such marks by Bosch Security Systems, Inc. is under license. Other trademarks and trade names are those of their respective owners.

For use in China: CHINA ROHS DISCLOSURE TABLE

针对在中国境内的使用：CHINA ROHS披露表

扬声器

根据SJ/T 11364-2014编制的有害物质表						
	Pb (Pb)	Hg (Hg)	Cd (Cd)	Cr 6+ (Cr 6+)	PBB (PBB)	PBDE (PBDE)
电路板	○	○	○	○	○	○
电子组件	x	○	○	○	○	○
换能器	x	○	○	○	○	○
显示屏	x	○	○	○	○	○
电缆和导线	○	○	○	○	○	○
塑料材料	○	○	○	○	○	○
金属材料	x	○	○	○	○	○
木质和纸质材料	○	○	○	○	○	○
涂料与涂层	○	○	○	○	○	○
本表系根据SJ/T 11364的规定编制而成						
○：上述有害物质在所有包含该物质的均质材料中的含量均低于GB/T 26572规定的限值						
x：上述有害物质在特定均质材料中的含量均高于GB/T 26572规定的限值						

关于该类产品生产日期代码的详细说明，请见：

<http://www.boschsecurity.com/datecodes/>

2 Short information

The following table lists products in a family, with CTN (Commercial Type Number) and identifying product name DESCRIPTION.

CTN	Description
EVOLVE50-TB	Column speaker array, pole, black
EVOLVE50-SB-US	Column speaker sub US, black
EVOLVE50-SB-EU	Column speaker sub EU, black
EVOLVE50-SB-AP	Column speaker sub AP, black
EVOLVE50-SB-GL	Column speaker sub, black, global, no BT
EVOLVE50-TW	Column speaker array, pole, white
EVOLVE50-SW	Column speaker sub, white, global w BT
EVOLVE50-SW-GL	Column speaker sub, white, global, no BT
EVOLVE50-PL-SB	Column speaker pole, short, black
EVOLVE50-PL-SW	Column speaker pole, short, white
EVOLVE50-CASE	Column speaker carrying case, wheels
EVOLVE50-SUBCVR	Subwoofer cover

2.1 Shipping contents

Quantity	Component
1	Subwoofer
1	Power cord
1	Installation manual
1	Warranty card
1	Safety manual

Table 2.1: Subwoofer box (EVOLVE50-US, EVOLVE50-EU, and EVOLVE50-AP models)

Quantity	Component
1	Subwoofer
2	Power cords
1	Installation manual
1	Warranty card
1	Safety manual

Table 2.2: Subwoofer box (EVOLVE50-SB-GL, EVOLVE50-SW, and EVOVLVE50-SW-GL models)

Quantity	Component
1	Column array
1	Sub pole
1	Carry bag

Table 2.3: Column array box (EVOLVE50-TB and EVOLVE50-SW models)

3 Description

Thank you for choosing an Electro-Voice portable column system. Please take time to consult the manual to understand all the features built into your EV system and fully utilize its performance capabilities.

The EVOLVE 50 portable column system is a new entry and form factor in the Electro-Voice portable sound portfolio. Designed to deliver an uncompromising combination of low-profile aesthetics and superior audio performance, the EVOLVE 50 sets a new standard for portable columnar systems.

EVOLVE 50 is designed to quickly and easily be transported and assembled. The three handle design on the subwoofer and convenient included carry case for the sub pole and column array provide minimal resistance to getting excellent, professional sound anywhere you need it. Installation is made easier via the symmetrical aluminum subwoofer pole with an integrated wire assembly. The connection is secured by the magnetic assisted latching system, which magnetically locks the sub pole in place.

The full-range column array and its eight 3.5-inch neodymium drivers are directed using custom-designed waveguides for consistent 120° coverage. The ported subwoofer enclosure houses a 12-inch woofer that is supported by 18 mm wood for enhanced stiffness and acoustical performance. The Class-D amplifier provides up to 1000 watts of output power: 500 watts to the subwoofer and 500 watts to the column array. The input panel features EV's industry-leading QuickSmartDSP interface—allowing intuitive navigation of system parameters via an LCD with single-knob control—as well as multiple options for signal routing and inputs.

The new Electro-Voice QuickSmart Mobile application utilizes Bluetooth® Low Energy (BTLE) technology for the wireless configuration, control, and monitoring of up to six EVOLVE 50 systems simultaneously. High-resolution Bluetooth® audio streaming adds convenience for wireless music playback in breakout rooms, intermission, and musical accompaniment. *Bluetooth® is available in select countries.*

Electro-Voice quality and testing procedures far exceed the industry norm to yield efficient and effective electro-acoustic performance; this creates components that deliver an accurate, linear response at the system's highest output levels. When applied to EVOLVE 50, this engineering philosophy results in a system that brings a new sonic benchmark to the column speaker segment, all packaged in a sleek and portable enclosure that blends into the background in any application from a lounge to a wedding reception.

3.1 System features





- EV QuickSmart Mobile application: quickly and wirelessly configure, control, and monitor up to six EVOLVE 50 systems simultaneously, and receive immediate notification during critical performance conditions. *Bluetooth® connectivity is available in select countries.*
- High-quality Bluetooth® audio streaming for background music or musical accompaniment. *Bluetooth® connectivity is available in select countries.*
- Ultra-wide 120° horizontal coverage via custom-designed waveguides and array-formed 40° asymmetrical vertical coverage means all acoustical energy is directed towards both sitting and standing audiences.

- QuickSmartDSP provides best-in-class processing via EV's signature single-knob user interface with LCD. Easy setup via four presets (Music, Live, Speech, Club), three-band EQ (low, mid, high), five user-programmable presets (Store and Recall settings), output delay, phantom power, visual monitoring of limiter status, input level control and meters, and master volume control to optimize gain structure.
- Ideal for portable applications. Light weight and intuitive assembly via the magnet assisted sub pole make a quality performance easier than ever.

3.2 Quick setup

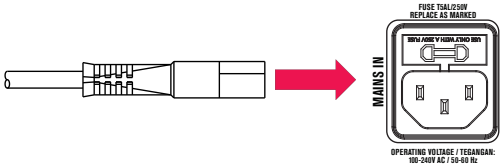
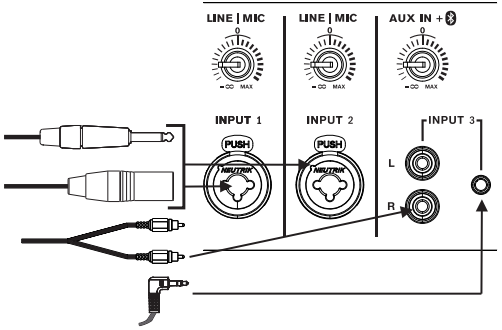
Subwoofer

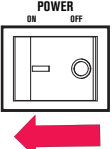
To set up a subwoofer, do the following:

Step	Illustration
1. Connect the AC power cord from a grounded line receptacle to the MAINS IN.	
2. Connect the XLR or TRS cables from an audio source to INPUT 1 or INPUT 2 or connect the RCA cable or 3.5 mm mini jack from an audio source to INPUT 3 .	
3. Adjust the input gain to $-\infty$ (infinity).	
4. Switch POWER to ON.	
5. From the DSP home screen, increase the input gain to the desired sound output.	
6. Adjust the MASTER VOL knob to the desired volume.	

Refer to

- Amplifier DSP, page 17

4 Installation



Caution!

Do not attempt to move this loudspeaker system when it is fully assembled.
You may damage the system or cause personal injury.

Assembling the loudspeaker system

To **assemble the loudspeaker system**, do the following:

1. Place the **subwoofer** on a level and stable surface.
2. Insert the symmetrical **pole** into the top of the subwoofer.

The pole has magnets (A) at each end. The pole can be inserted on either end.



3. Place the **column array loudspeaker** on top of the subwoofer pole.



4. The **column array loudspeaker system** set up is complete.



5 Amplifier DSP

5.1 Amplifier DSP controls

The amplifier has a combination of controls and connectors to ensure the most versatile loudspeaker system.

Portable column system control and monitoring interface

The portable column system DSP control menu selections are available for the EVOLVE 50 .

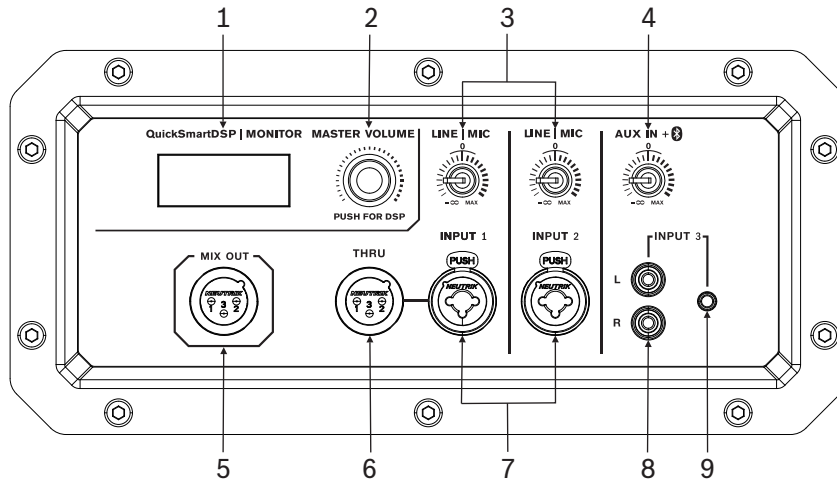

1. **LCD** – DSP control and monitoring interface.
2. **MASTER VOL** – Adjusts the sound level.
DSP – Scroll through the menu and select the available choices. Push the MASTER VOL knob to enter the DSP menu.
3. **LINE | MIC** – Electronically balanced INPUT 1 and INPUT 2 MIC/LINE for the connection of a line level signal source (such as mixer etc.) or a microphone. Phantom power (+15 V) can be enabled Phantom 1 or 2 if a condenser microphone is being used. Establishing a connection is possible via TRS or XLR-type plugs. Whenever possible, balanced signal feed is always preferable to guard against potential noise or HF-interference. This control lets you optimally adjust the incoming signals to match the sensitivity of the system.
4. **AUX IN** – Control to adjust the input trim of the stereo RCA type, 3.5mm, or Bluetooth® streaming inputs. This control lets you optimally adjust the incoming signals to match the sensitivity of the system. *Bluetooth®connectivity is available in select countries.*
5. **MIX OUT** – The post-fader audio signals of INPUT 1, INPUT 2 and INPUT 3 are mixed and passed to MIX OUT. The ratio of the input signals changes when the level controls INPUT 1, 2 or 3 are adjusted. This feature allows the loudspeaker to act as a basic three-channel mixer that can send the mix to another loudspeaker via the MIX OUT socket. This output is laid out in GND-SENSING technology, a special pin assignment of the output socket, offering all advantages of the balanced signal transmission, but lets you also connect monaural plugs without a problem.
6. **THRU** – The THRU output socket is connected in parallel to INPUT 1, it is used for carrying through the pre-fader input signal to additional powered loudspeaker or subwoofer.
7. **INPUT** – Electronically balanced INPUT 1/2 MIC/LINE for the connection of a line level signal source (such as mixer etc.) or a microphone. Establishing a connection is possible via TRS or XLR-type plugs. Whenever possible, balanced signal feed is always preferable to guard against potential noise or HF-interference.
8. **INPUT 3 RCA Connector** – Stereo unbalanced RCA type INPUT 3 AUX IN for connecting sources such as CD players or MP3 players.

9. **INPUT 3 3.5mm connector** – Balanced mono or unbalanced stereo input for mobile phones, laptops, etc.

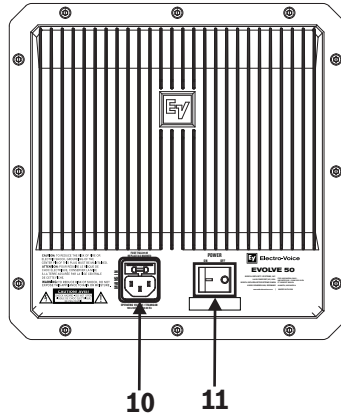

Notice!

Markings and statements on amplifier panel may vary.

10. **MAINS IN** – The device receives its power supply via the MAINS IN socket. Only the provided power cord may be used. Connect the device only to a mains network, which corresponds to the requirements indicated on the type plate.
11. **POWER** – AC switch for switching the power ON or OFF. The LCD screen lights up when the power is turned ON, after approximately 3 seconds.

5.2

System status

Normal

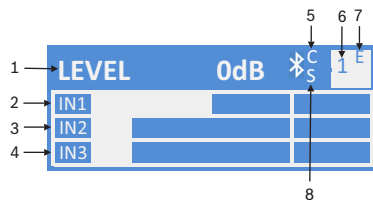

Figure 5.1: Normal system status home screen with Bluetooth® status

1. **LEVEL** – Indicates the master gain of the system in dB. The range is from mute to +10 dB, in 1 dB increments.
2. **IN1** – VU meter displays the signal level of INPUT 1 into the amplifier INPUT 1 XLR connector. IN1 and IN2 are independent of each other.
3. **IN2** – VU meter displays the signal level of INPUT 2 into the amplifier INPUT 2 XLR connector. IN1 and IN2 are independent of each other.
4. **IN3** – VU meter displays the signal level of INPUT 3.
5. **C** - Control app. The available options are:
OFF - DISABLED
FLASHING - PAIRING MODE
SOLID - CONNECTED
6. **1** - Indicates the selected store function number. There are five user defined store function numbers available.
7. **E** - Edited. Indicates the preset is not saved. When the preset is saved, the E is not displayed.
8. **S** - Audio streaming; the available options are:

OFF - DISABLED
 FLASHING - PAIRING MODE (120s)
 SOLID - CONNECTED



Notice!

Bluetooth® is available in selected countries.
 Contact your nearest Electro-Voice dealer or Electro-Voice distributor for more information.

System protection

System protection limiters indicate when a system is exceeding recommended usage by indicating CLIP or LIMIT on the LCD display.

CLIP

CLIP indicates the signal to the loudspeaker is too high, resulting in a clipped signal into the loudspeaker. If CLIP is shown, reduce the input gain knob and/or the signal on the mixer or source equipment.

LIMIT

LIMIT protects the loudspeaker from short-term peaks which can cause distortion. When LIMIT is shown small on the screen, the limiter is active but keeps distortion under control. The large LIMIT indicates the sound is negatively affected. Reducing the output volume (MASTER VOL) is strongly recommended when the large limit indication is shown.

AMP HOT!

AMP HOT! indicates that the amplifier has heated up to a point where the loudspeaker will cut out or shut down.

If **AMP HOT!** is shown:

- ▶ Make sure the system is not in direct sunlight or near another heat source.
- ▶ Ensure that the system’s airflow is not obstructed and that the rear panel is not covered.
- ▶ If possible, switch off the system and give it time to cool down.

After cooling down, if the system still displays **AMP HOT!**, contact your Sales or Customer Service Representative.

Refer to

- Pairing the QuickSmart Mobile application, page 26

5.3

DSP control menu

EXIT	
MODE	MUSIC (Default)
	LIVE
	SPEECH
	CLUB
SUB LEVEL	0 dB (Default)
	Mute, -80 dB to +10 dB
TREBLE	0 dB (Default)
	-12 dB to +6 dB

MID		0 dB (Default)
		-12 dB to +6 dB
MID FREQ		1200 Hz (Default)
		200 to 12000 Hz
BASS		0 dB (Default)
		-12 dB to +6 dB
PHANTOM 1		ON
		OFF (Default)
PHANTOM 2		ON
		OFF (Default)
MIX OUT		L+R (Default)
		R
DELAY	FEET	OFF (Default)
	METERS	OFF, 0.1 to 100.0 m (and ft.)
LED		OFF
		ON (Default)
		LIMIT
		CONTROL APP
DISPLAY	BACK	
	LCD DIM	ON (Default)
		OFF
	BRIGHT	5 (Default)
		1 to 10
	CONTRAST	5 (Default)
1 to 10		
BACK		
STORE		EXIT, 1, 2, 3, 4, 5, EXIT
RECALL		EXIT, 1, 2, 3, 4, 5, EXIT
BLUETOOTH	CONTROL APP	ON
		OFF (Default)
	STREAMING	PAIRING
		ON
		OFF (Default)
RESET		RESET ALL SETTINGS?

	NO (Default)
	YES
INFO	[PRODUCT NAME]
	[FIRMWARE VERSION]
	©2017 Electro-Voice
EXIT	

Table 5.1: Portable column system DSP Control Menu

EXIT menu

The **EXIT** menu is used to return to the home screen.



Notice!

The display returns to the home screen after two minutes of inactivity.

MODE menu

The **Mode menu** is used to configure the type of sound the subwoofer delivers.

- **MUSIC** - is used for recorded music playback and electronic dance music applications.
- **LIVE** - is used for live sound applications.
- **SPEECH** - is used for spoken word applications.
- **CLUB** - is used for recorded electronic music playback.

SUB LEVEL Menu

The **Sub Level** menu allows independent gain control of the subwoofer output. Changes to this parameter effectively change the crossover of the EVOLVE 50 system. The default setting of 0 dB is recommended for best audio performance.

The range is *MUTE*, -80 dB to +10 dB.

The default is 0 dB.

TREBLE Menu

The **Treble** menu is used to adjust the high frequency performance of the loudspeaker for different applications or personal preference. The parameter controls a high shelving filter that is centered on 6 kHz.

The range is -12 dB to +6 dB.

The default is 0 dB.

MID menu

The **MID** menu is used to set the gain of the MID peak filter.

The range is -12 dB to +6 dB.

The default is 0 dB.

MID FREQ Menu

The **MID Freq** menu is used to set the center frequency of the MID peak filter.

The range is 200 -12000 Hz.

The default is 1200 Hz.

BASS menu

The **Bass** menu item is used to configure the low frequencies of sound.

The range is -12 dB to +6 dB.

The default is 0 dB.

PHANTOM 1 or PHANTOM 2 Menu

The Phantom 1 or Phantom 2 menu is for activating phantom power (+15 V) of audio INPUT 1 or 2 whenever a suitable condenser microphone is being used. Available options for this selection are: ON or OFF.

The default is **OFF**.

MIX OUT menu

The **Mix Out** menu is used to select which signal of INPUT 3 AUX IN should be output at MIX OUT and which signal should be delivered by the loudspeaker.

- **L+R**: The left and right signals of INPUT 3 are summed. The sum is output at MIX OUT and is delivered by the loudspeaker. (Default)
- **R**: Only the right signal of INPUT 3 is output at MIX OUT. The loudspeaker will deliver only the left signal.

DELAY Menu

The **Delay** menu is used to delay the output signal, e.g. to compensate for differences in distance among individual loudspeakers. The delay can be set in meters or feet. Available options for this selection are: OFF or a delay up to 100.0 m or 328 ft. The delay can be changed in 0.1 meter increments or 0.1 foot increments.

The default is **OFF**.

DISPLAY menu

The **Display** menu options are BACK, LCD DIM, BRIGHT, and CONTRAST.

LED menu

The **LED** menu shows power on and indicates limit. Available options for this selection are: ON, OFF, LIMIT or CONTROL APP.

- **ON** - turns the LED on when the power to the loudspeaker is ON. (Default)
- **OFF** - turns the LED off.
- **LIMIT** - turns the LED off under normal operation. The LED brief blinking indicates the limiter is activating. Short-term blinking is not critical because the integrated limiter keeps distortion under control. Constant lighting of the LED indicates the sound is negatively affected. If the LED is constantly lit, check the rear LCD for more information. Reducing the output volume is strongly recommended.
- **CONTROL APP** - indicates if Bluetooth® on the portable column system is trying to pair or is connected to a Bluetooth® enabled mobile device. In pairing mode the LED will flash blue indicating it is ready to pair. The LED is solid blue when it is connected.

The default is **ON**.

LCD DIM Menu

The **LCD Dim** menu is used to dim the display when the display is idle for 30 seconds. Available options for this selection are: ON or OFF.

The default is **ON**.

BRIGHT menu

The **BRIGHT** menu is used to determine the brightness of the LCD.

The range is 1 to 10.

The default is five.

CONTRAST menu

The **CONTRAST** menu is used to increase or decrease the visibility of the LCD screen based on lighting conditions.

The range is 1 to 10.

The default is five.

STORE menu

The **STORE** menu allows you create up to five customized user settings. Available options for this selection are: **EXIT**, **1**, **2**, **3**, **4**, and **5**.



Notice!

The customized user setting name can contain a combination of alphanumeric characters including spaces. The alphanumeric character range is A to Z and 0-9.

The name field length is 12 characters.

Storing customized user settings

To store customized user settings, do the following:

1. From the **DSP** menu, scroll to **STORE**.
2. Push the **MASTER VOL** knob to select **STORE**.
The **STORE** screen appears.
3. Push the **MASTER VOL** knob to select 1.
The **Enter name for 1** screen appears.
4. Use the **MASTER VOL** knob to scroll through the characters.
The characters appear.
5. Push the **MASTER VOL** knob to select the required character.
6. Turn the **MASTER VOL** knob to move to the next character entry.
Continue selecting characters until the required name is entered.
7. Use the **MASTER VOL** knob to scroll to **SAVE**.
8. Push the **MASTER VOL** knob to select **SAVE**.
9. Repeat steps 3 through 8 to store additional customized user settings.
10. Select **EXIT** to return to the home screen.

RECALL Menu

The **Recall** menu allows you retrieve up to five customized user settings. Available options for this selection are: **EXIT**, **1**, **2**, **3**, **4**, and **5**.

Recalling customized user settings

To recall customized user settings, do the following:

1. From the **DSP** menu, scroll to **RECALL**.
2. Push the **MASTER VOL** knob to select **RECALL**.
The recall screen appears.
3. Push the **MASTER VOL** knob to select 1.
The selected item is loaded.
4. Select **EXIT** to return to the home screen.

BLUETOOTH

The **Bluetooth** menu options are **CONTROL APP** and **STREAMING**.

CONTROL APP menu

The **CONTROL APP** menu is used to enable the QuickSmart Mobile wireless control and monitoring application. Available options for this selection are: **ON** or **OFF**.

The default is **OFF**.



Notice!

Bluetooth® is available in selected countries.

Contact your nearest Electro-Voice dealer or Electro-Voice distributor for more information.

The Bluetooth® word mark and logos are registered trademarks owned by Bluetooth SIG, Inc. and any use of such marks by Bosch Security Systems, LLC is under license. Other trademarks and trade names are those of their respective owners.

Turning Bluetooth® ON or OFF

To turn Bluetooth® ON or OFF, do the following:

1. From the DSP menu, scroll to **CONTROL APP**.
2. Select **ON**.
OR
Select **OFF**.

STREAMING

The **Streaming** menu is used to stream audio from your Bluetooth® enabled device to the loudspeaker system. Available options for this selection are: PAIRING, ON or OFF.

The default is **OFF**.

Pairing the portable column system with your Bluetooth® enabled device

To **pair the portable column system with your Bluetooth® enabled device**, do the following:

1. From the DSP menu, scroll to STREAMING.
2. Select PAIRING.
PAIRING mode enables 120 seconds of visibility to Bluetooth® enabled devices.
3. On your mobile device, select **EV EVOLVE** to initiate the pairing process.
Once the device is paired, all device audio will be output through the EVOLVE 50 system.



Notice!

If connected with a mobile device, notification alerts and ring tones will also be played through the system.

Disable these notifications or enable Airplane mode on your mobile device to prevent unwanted interruptions during audio playback.

Turning streaming ON or OFF

To **turn streaming ON or OFF**, do the following:

1. From the DSP menu, scroll to **STREAMING**.
2. Select **ON**.
OR
Select **OFF**.

RESET menu

The **RESET** menu is used to reset the loudspeaker to original factory settings. Available options for this selection are: **NO** or **YES**.

The default is **NO**.

Resetting the system

To **reset the system to original factory settings**, do the following:

1. From the DSP menu, select **RESET**.
The "RESET ALL SETTINGS?" validation message appears.
2. Select **YES**.
The system is reset to the original factory settings.



Notice!

The **RESET** menu item is used to revert the loudspeaker to the original factory default settings. All user settings will be deleted. The user customized settings in the **STORE** and **RECALL** menus return to <EMPTY>.

INFO menu

The **INFO** menu is used to display the product name and firmware version.

Refer to

- *Pairing the QuickSmart Mobile application, page 26*

6 Pairing the QuickSmart Mobile application

The EV QuickSmart Mobile app for tablets and smartphones is available for download from the iTunes App Store and the Google Play Store.

Download and check the app for the latest firmware updates to enjoy optimal audio performance and maximize your control of the system.



Notice!



The EV QuickSmart Mobile app is designed to only find speakers from Electro-Voice with Bluetooth® enabled.

The EV QuickSmart Mobile app will not display other types of Bluetooth® devices, e.g. phones, laptops, tablets, or headsets.

Notice!



Bluetooth® is available in selected countries.

Contact your nearest Electro-Voice dealer or Electro-Voice distributor for more information.

Prior to pairing the EV QuickSmart Mobile app with loudspeakers by Electro-Voice ensure Bluetooth® is enabled on the smart phone or tablet, and the loudspeaker.

First time pairing

1. Open the EV QuickSmart Mobile app. 
1. In the DSP control menu of the loudspeaker, set **CONTROL APP** to **ON**.
2. **Select your Speakers** is displayed on the screen.
The EV QuickSmart Mobile app is looking for available Bluetooth® enabled Electro-Voice loudspeakers.
3. The available loudspeakers are displayed on the screen.
The app will display up to eight available loudspeakers.
4. Tap the loudspeaker(s) you want to pair with the app.
A red line under the selected loudspeaker(s) confirms the selection.
The app can connect up to six loudspeakers.
5. Tap the red **CONNECT** button.
6. The app pairs with the required loudspeaker.

7 Recommended configurations

7.1 Stereo pair of EVOLVE 50 systems

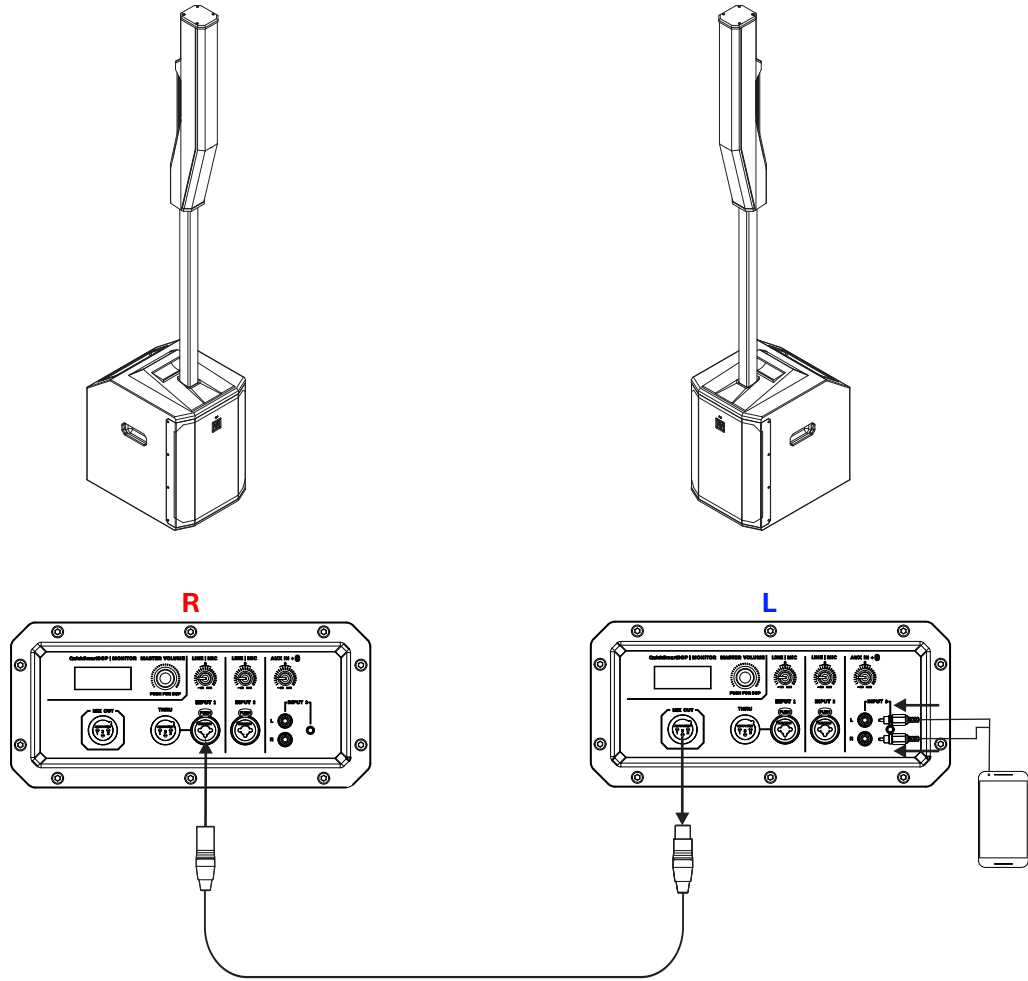

R	Right
L	Left



Notice!
The direction of the arrow indicates the signal path.

Mode:	Music
MIX-OUT:	R

Table 7.1: DSP settings for the portable column system

Refer to
– DSP control menu, page 19

7.2 Solo musician performance

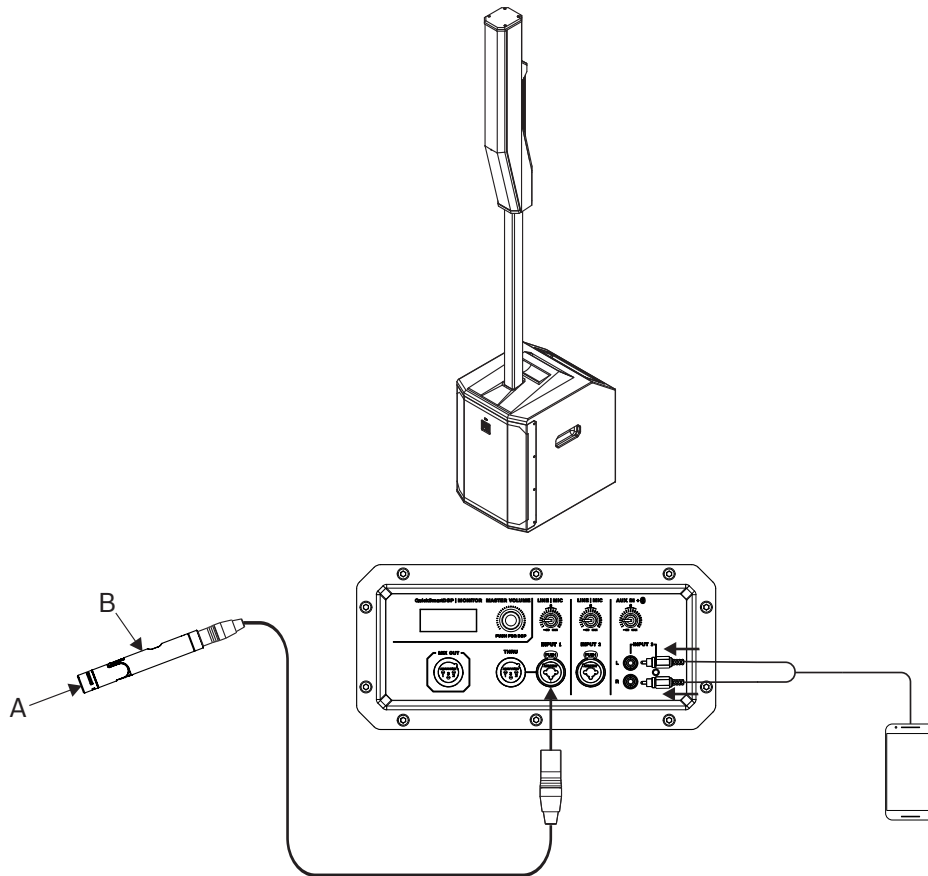

A	Guitar, conga drum, etc.
B	Condenser microphone



Notice!
The direction of the arrow indicates the signal path.

Mode:	Live
Phantom 1:	On

Table 7.2: DSP settings for the portable column system

Refer to
– DSP control menu, page 19

8 Troubleshooting

Problem	Possible cause	Action
1. No sound	Amplifier	Verify all the electronics are on, the signal routing is correct, the source is active; the volume is turned up, etc. Correct/repair/replace as necessary. If there is still no sound, the problem may be wiring.
	Wiring	Verify you have connected the correct cables to the amplifier. Play something at a low level through the amplifier. Connect a test loudspeaker in parallel with the malfunctioning line. If the sound level is gone or is very weak, the line has a short in it (possibly a severe scrape, pinch, or a missed connection). Using the test loudspeaker, move down the line and test each connection/junction until you find the problem and correct it. Observe proper polarity.
2. Intermittent output such as crackling or distortion	Faulty connection	Check all connections at amplifier and loudspeakers to ensure they are all clean and tight. If the problem persists, check the wiring. See problem 1.
3. Constant noise such as buzzing hissing or humming	Defective source or other electronic device	If noise is present, but no program material is playing, evaluate each component as necessary to isolate the problem. Most likely there is a break in the signal path.
	Poor system grounding or ground loop	Check and correct the system grounding, as required.
	Input gain knob is not in the MIC position	Slowly increase the input gain knob level to engage the microphone pre-amp.
4. No sound produced with microphone connected to INPUT 1 or INPUT 2	Microphone requires phantom power.	Use a dynamic microphone that does not require phantom power (+15 V). If using a microphone requiring phantom power, enable PHANTOM POWER in the DSP menu, or use an external phantom power source.
	Input gain knob is not in the MIC position	Slowly increase the input gain knob level to engage the microphone pre-amp.
5. Sound is distorted front LED is OFF, LCD screen LIMIT is ON	Excessive input level	Reduce the input level or loudspeaker level knobs to prevent limit.
	Incorrect gain structure or source input (mixing console/preamp) is overdriven	Verify level controls of the source are properly structured by using the VU meter indicator on the LCD screen. If the VU meter bar is solid or the system indicates LIMIT, the input or source level is too high.

Problem	Possible cause	Action
6. Microphone produces acoustic feedback when input level is amplified	Incorrect gain structure	Reduce the microphone levels at the mixing console or input source. If the microphone is connected directly to the speaker, reduce the input level on the speaker. Positioning the microphone close to the sound source increases gain-before-feedback. See problem 6.
	MODE is set to MUSIC	Change the MODE to LIVE or SPEECH.
	Microphone position is too close to the front of the loudspeaker	Whenever possible setup the loudspeakers so the microphone is behind them. If using the loudspeaker in a monitor position, aim the loudspeaker to the back of the microphone.
7. DSP menu is locked	The Menu Lock function has been turned on.	Press and hold the MASTER VOL knob for 5 seconds.
8. QuickSmart Mobile app does not detect the loudspeaker	Enable Bluetooth®	Ensure Bluetooth® is enabled on the loudspeaker.

If these suggestions do not solve your problem, contact your nearest Electro-Voice dealer or Electro-Voice distributor.

9 Technical data

Frequency response (-3 dB) ¹ :	43 Hz-20 KHz
Frequency range (-10 dB) ¹ :	37 Hz-20 KHz
Maximum SPL ² :	127 dB
Coverage (H x V):	120° x 40°
Amplifier rating:	1000 W
LF channel rating:	500 W
HF channel rating:	500 W
Crossover frequency:	200 Hz
Connectors:	2x XLR/TRS Combo Jack Input 1x 3.5 mm Input 1x Stereo RCA Input 1x Wireless Bluetooth® Audio Input 1x XLR THRU Output 1x XLR MIX OUT Output
Enclosure:	Sub: 15 mm plywood Column: Composite Pole: Aluminum
Grille:	Steel with black or white powder coat
Color:	Black or white
Dimensions (HxWxD): mm (in)	Sub: 530 x 345 x 471 (20.9 x 13.6 x 18.5) Column: 825 x 102 x 172 (32.5 x 4.0 x 6.9) Pole: 929 x 48.5 x 55 (36.6 x 1.9 x 2.2)
Net weight:	Sub: 44.66 lb (20.3 kg) Column: 10.34 lb (4.7 kg) Pole: 2.75 lb (1.25 kg) Sub cover: 0.9 lb (0.4 kg) Bag for column and pole: 1.87 (0.85 kg)
Shipping weight:	Sub box: 50.71 lb (23 kg) Column box: 18.30 lb (8.3 kg)
Power consumption ³ :	100-240 V AC, 50-60 Hz, 1.5-0.6 A

¹Full-space measurement using music DSP preset.

²Maximum SPL is measured at 1 m using broadband pink noise at maximum output.

³Current rating is 1/8 power.

9.1 Dimensions

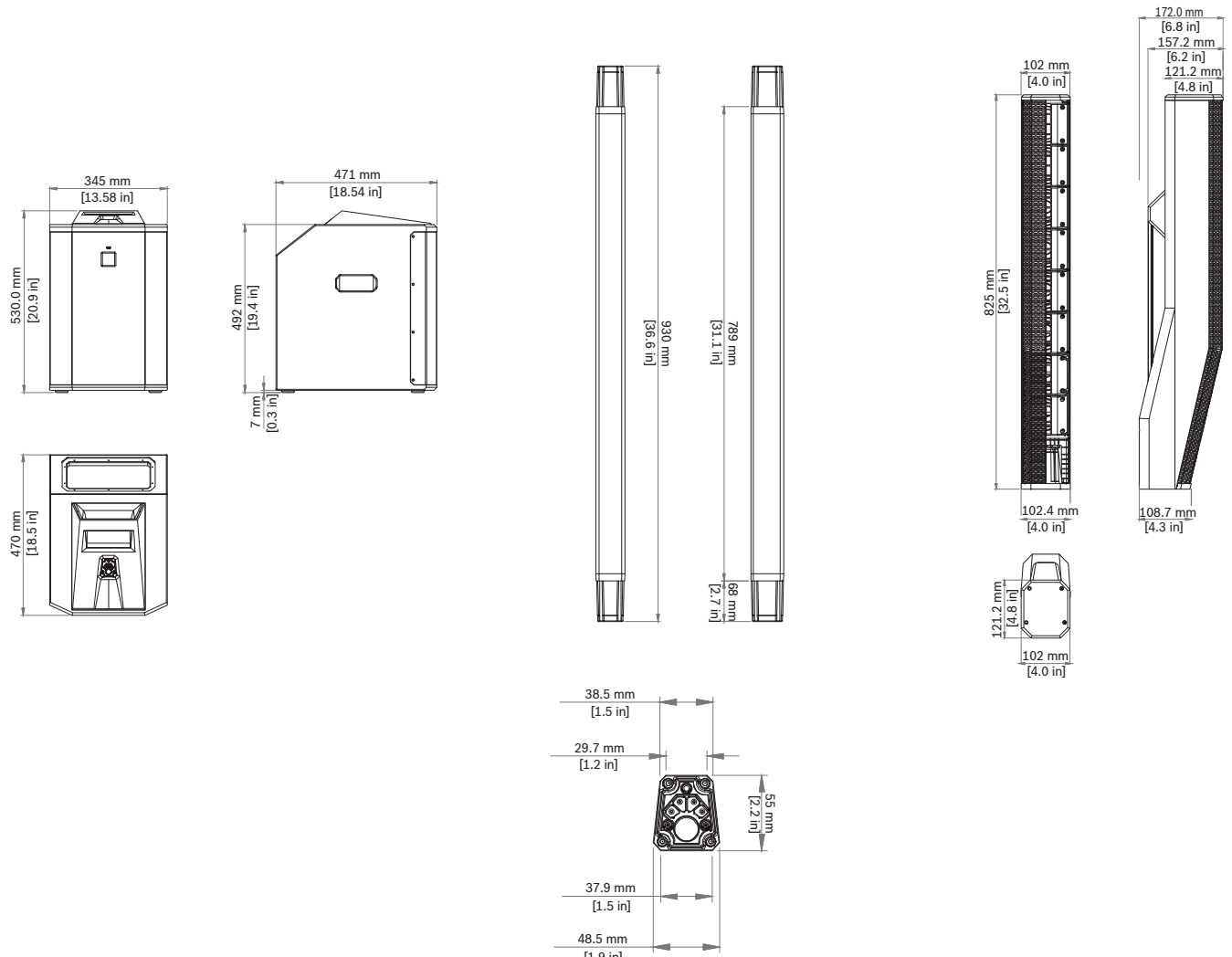

Figure 9.1: Dimensions EVOLVE 50 (subwoofer left, spacer center, and column right)

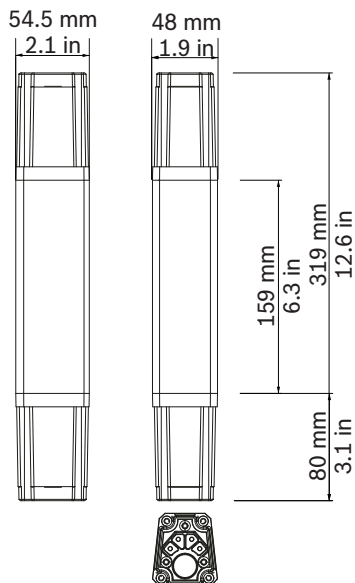

Figure 9.2: Dimensions EVOLVE 50 short pole

9.2 Frequency response

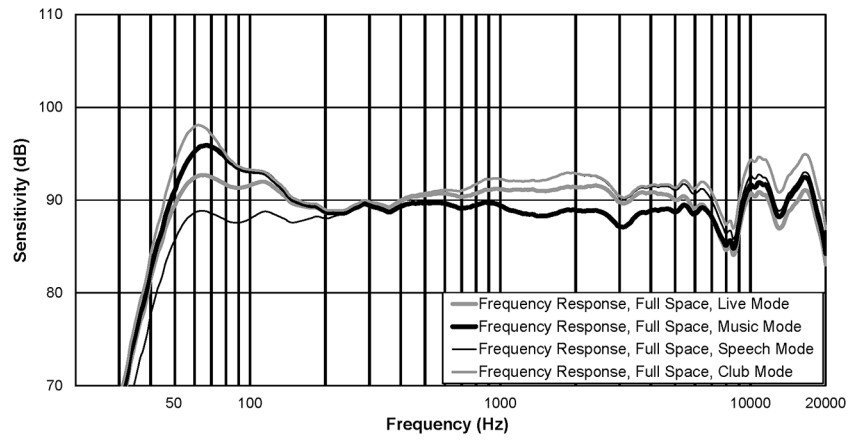
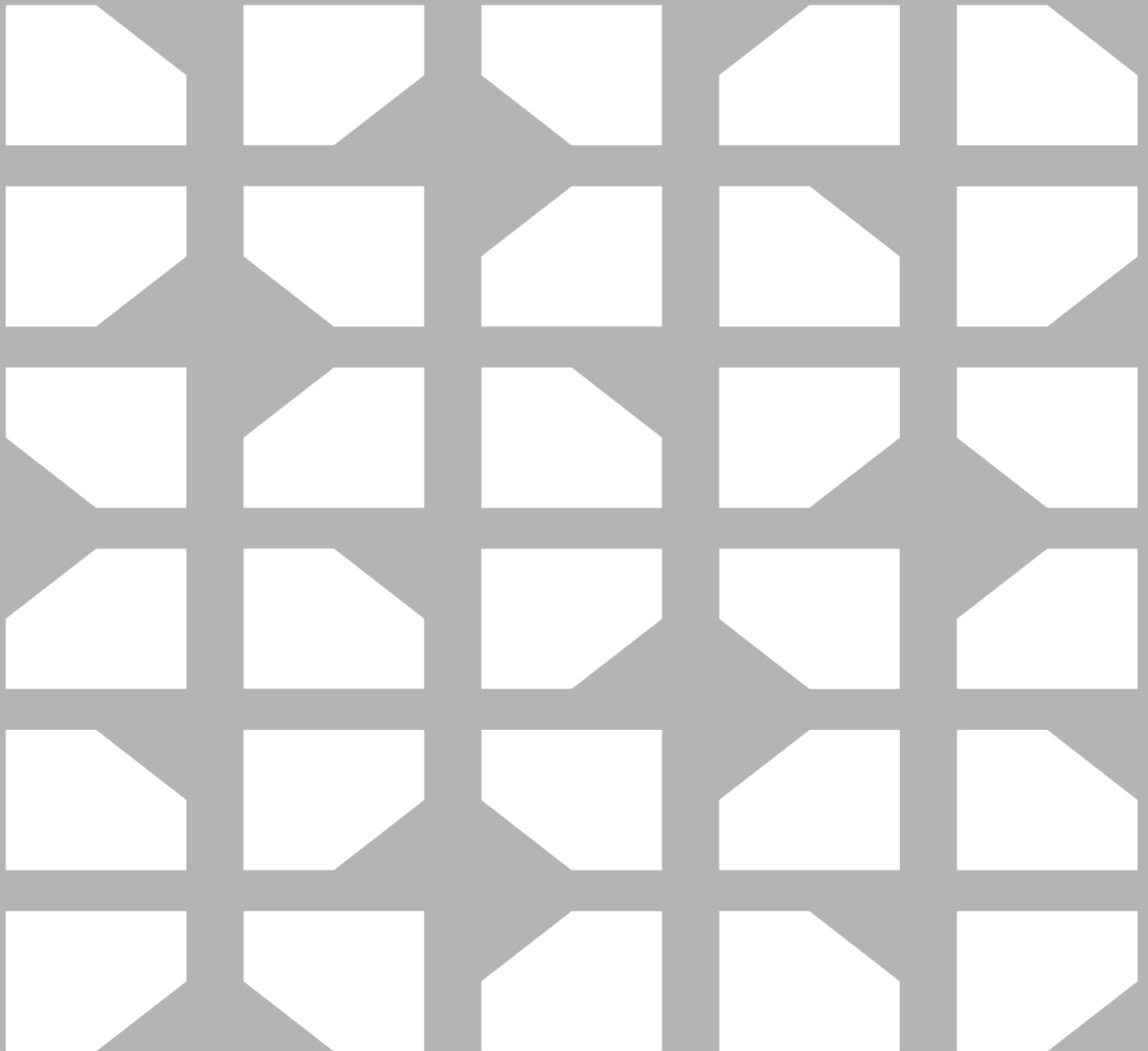

Figure 9.3: Frequency response EVOLVE 50 (Live Mode, Music Mode, Speech mode, and Club Mode)



Bosch Security Systems, LLC

130 Perinton Parkway

Fairport, NY 14450

USA

www.electrovoice.com

© Bosch Security Systems, LLC, 2025

EU importer:

Bosch Sicherheitssysteme GmbH

Robert-Bosch-Platz 1

70839 Gerlingen

Germany

© Bosch Sicherheitssysteme GmbH, 2025