

Product registration



Register your ZLX-G2: electrovoice.com/register

Quick setup

The ZLX series loudspeakers from Electro-Voice are fully integrated audio systems with carefully matched electronics and transducers. These products make it easy to setup a high quality sound system quickly with a minimum amount of cables and external electronics.

Full-Range powered loudspeaker

Models: ZLX-8P-G2-US, ZLX-12P-G2-US, ZLX-15P-G2-US, ZLX-8P-G2-EU, ZLX-12P-G2-EU, and ZLX-15P-G2-EU.

Step	Illustration
1. Connect the AC power cord from a grounded receptacle to the MAINS IN .	
2. Switch power to ON .	
3. Adjust the volume to 0 dB by using the MASTER VOLUME knob.	
4. Push the input selection soft key for INPUT 1 or INPUT 2 if using an XLR or 1/4-inch (6.35 mm) cable. Use the MASTER VOLUME knob to adjust INPUT LEVEL to MUTE . Repeat for each input channel as needed.	

5. Connect an audio source using an XLR, TRS, or TS cable to **INPUT 1** or **INPUT 2**. Ensure audio source is **MUTE** or at a low level before making connection. After connection is made, increase the source's output to a reasonable level. Ensure that the source is not being clipped.

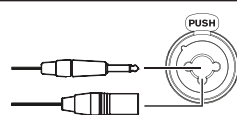

6. Adjust the **INPUT LEVEL** by using the **MASTER VOLUME** knob until the signal peaks are just below maximum level or the required output is achieved. If **PK** or **PEAK** is indicated, turn the level down until the **PK** or **PEAK** indication disappears. Press the input selection soft key again to exit the channel menu. Use the same process for other inputs if in use. Adjust the input levels of each input to achieve the desired mix.

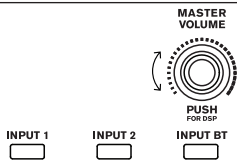

7. Using the **MASTER VOLUME** knob, adjust the volume until you get the required output from the loudspeaker.

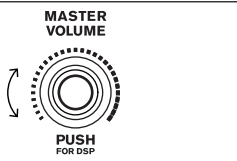

Pairing the QuickSmart Mobile app

The EV QuickSmart Mobile app for tablets and smartphones is available for download from the Apple App Store and the Google Play Store.

Download and check the app for the latest firmware updates to enjoy optimal audio performance and maximize your control of the system.



Notice!

The EV QuickSmart Mobile app is designed to only find loudspeakers from Electro-Voice featuring Bluetooth® control functionality. The EV QuickSmart Mobile app will not display other types of Bluetooth® devices, e.g. phones, laptops, tablets, or headsets.



Prior to pairing the EV QuickSmart Mobile app with Electro-Voice loudspeakers:

1. Ensure that Bluetooth® is enabled on the smartphone or tablet.
2. Ensure that pairing mode is enabled on the loudspeaker.

To place the loudspeaker in pairing mode for both control and streaming:

1. Press and hold **INPUT BT** until **Pairing Mode On** and the 4-digit ID is shown on the LCD. Pairing mode can be enabled through the LCD menu for control and streaming separately. The loudspeaker remains in control pairing mode for about 2 minutes. If control pairing fails, repeat this step.

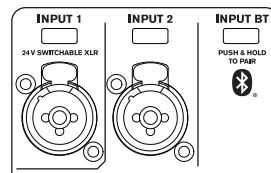

2. Navigate to your mobile device's Bluetooth® settings menu, find the ZLX-G2 loudspeaker with the matching 4-digit ID and ensure you are paired to the loudspeaker. This will pair the mobile device to the ZLX-G2 loudspeaker for audio streaming.
3. Continue to the next step to pair for control.

Notice!

For Android devices running Android version 11 or older, ensure location services are allowed. Electro-Voice does not collect, store, or track user location data or personal information.



First time pairing

1. Open the EV QuickSmart Mobile app.
2. **Select your Speakers** is displayed on the screen. The EV QuickSmart Mobile app is looking for available Bluetooth® enabled Electro-Voice loudspeakers. The available loudspeakers are displayed on the screen.
3. Tap the loudspeaker you want to pair with the app. The selected loudspeaker will have a line under it acknowledging it is selected.
4. Repeat the previous step until all of the required loudspeakers are selected.

5. Tap the **CONNECT** button.
6. The app connects with the selected loudspeaker. You will get a message from iOS/iPadOS/Android about pairing for each device which has to be accepted.

Notice!



If the message "Bluetooth Connection failed" appears, ensure that control pairing mode is enabled in the loudspeaker.

7. Tap **PAIR** on the device to accept pairing to the loudspeakers. The app can connect to up to six loudspeakers.

Subsequent pairing

To pair additional loudspeakers with the EV QuickSmart Mobile app:



1. Tap the EV QuickSmart Mobile app icon.
2. **Select your Speakers** is displayed on the screen. The EV QuickSmart Mobile app is looking for available Bluetooth® enabled Electro-Voice loudspeakers. The available loudspeakers are displayed on the screen.
3. Tap the loudspeaker you want to pair with the app. The selected loudspeaker will have a line under it acknowledging it is selected.
4. Repeat the previous step until all of the required loudspeakers are selected.
5. Tap the **CONNECT** button. The app connects with the required loudspeaker. The app can connect to up to six loudspeakers.

Tripod or pole mount

ZLX portable loudspeakers mount on a tripod stand or on a pole above a subwoofer.

Mounting a loudspeaker on a tripod stand

Caution!



Tripod is not evaluated for safety with this loudspeaker. Check the specifications of the tripod stand to be certain it is capable of supporting the weight of the loudspeaker.

Caution!



Do not stack additional loudspeakers.

Caution!



We recommend that two or more persons lift and place heavier loudspeakers. Single person lift and placement of heavier loudspeakers could cause injury.

To mount a loudspeaker on a tripod stand, do the following:

1. Place the tripod stand on a level and stable surface.
 - Fully extend the legs on the tripod stand.
 - Do not compromise the tripod stand's structural integrity by trying to make the stand taller.
 - Do not attempt to mount more than one loudspeaker on a stand designed for a single loudspeaker.
2. Loosen the set screw.

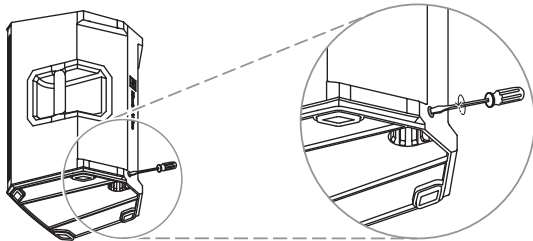

Fig. 1: 8-inch models

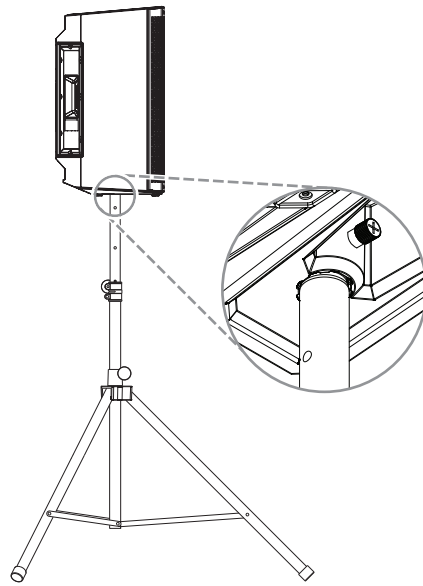
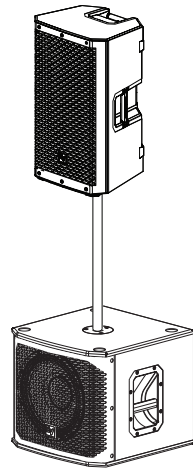

Fig. 2: 12- and 15-inch models

3. Lift the loudspeaker using two hands.
4. Set the pole cup located on the bottom of the loudspeaker onto the pole.
5. Tighten the set screw to secure the loudspeaker to the pole.

Mounting a loudspeaker on a pole



Caution!

We recommend that two or more persons lift and place heavier loudspeakers. Single person lift and placement of heavier loudspeakers could cause injury.

To mount a loudspeaker on a pole, do the following:

1. Place the subwoofer on a level and stable surface.

2. Insert the pole into the pole cup on the top of the subwoofer.
3. If you are using a threaded pole mount, turn the pole clockwise to secure the pole to the subwoofer.
OR
If you are not using a threaded pole mount, continue to the next step.
4. Loosen the set screw.
5. Lift the loudspeaker using two hands.
6. Set the pole cup located on the bottom of the loudspeaker onto the pole.
7. Tighten the set screw to secure the loudspeaker to the pole.



Caution!

Do not stack additional loudspeakers.

Warranty information

For information on warranty periods and after sales service, please visit: www.electrovoice.com/warranty

Full-range powered loudspeaker

ZLX-8P-G2, ZLX-12P-G2, ZLX-15P-G2

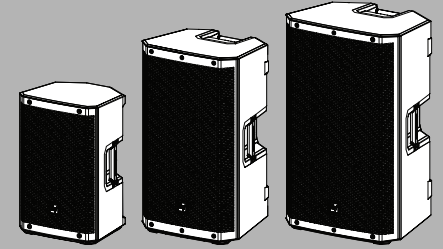

en Quick user guide



Bosch Security Systems, LLC

130 Perinton Parkway
Fairport, NY 14450
USA

www.electrovoice.com

© Bosch Security Systems, LLC, 2025

EU importer:

Bosch Sicherheitssysteme GmbH

Robert-Bosch-Platz 1
70839 Gerlingen
Germany

© Bosch Sicherheitssysteme GmbH,
2025

