

EVOLVE Column Loudspeaker System

EVOLVE70-90-TB, EVOLVE70-90-TW, EVOLVE70-SB,
EVOLVE70-SW, EVOLVE90-SB, EVOLVE90-SW

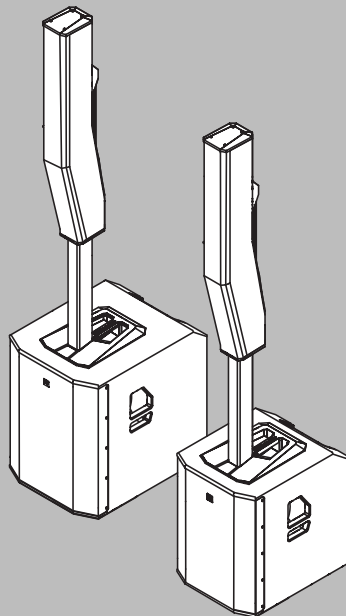





Table of contents

1	Safety	4
1.1	Important safety instructions	4
1.2	Precautions	7
1.3	Suspension	7
2	Product registration	8
3	Short information	9
3.1	Parts included	9
4	Description	11
4.1	Quick setup	11
5	Installation	13
6	Pairing the QuickSmart Mobile application	14
7	Amplifier DSP	16
7.1	Amplifier DSP controls	16
7.2	System status	19
7.3	DSP control menu	21
7.3.1	Loudspeaker DSP control menu	22
8	Input & Mixer operation	28
8.1	INPUT DSP control menu	28
8.2	Using AES/EBU digital audio interface	30
9	Recommended configurations	32
9.1	Stereo pair of EVOLVE70-90 systems	32
9.2	DJ performance	34
9.3	Speaking event	35
9.4	Bluetooth true wireless stereo (TWS)	36
9.5	Stereo with cardioid subwoofer	37
10	Troubleshooting	38
11	Technical data	40
11.1	Block diagram	43
11.2	Dimensions	44
12	Appendices	49
12.1	Effects (FX) list	49
12.2	Warranty information	50
12.3	OUTPUT list	50
12.4	INPUT list	53
12.5	Regulatory information	55
12.5.1	FCC information	55
12.5.2	Simplified Declaration of Conformity (sDoC) for Europe (CE)	56
12.5.3	Regulatory notice for CE - Information concerning the use of apparatus	58
12.5.4	Certifications	59
12.5.5	Notices	60

1 Safety

1.1 Important safety instructions

 <p>WARNING: TO REDUCE THE RISK OF FIRE OR ELECTRIC SHOCK, DO NOT EXPOSE THIS APPLIANCE TO RAIN OR MOISTURE</p> <p>AVIS: RISQUE DE CHOC ELECTRIQUE, NE PAS OUVRI.</p> <p>WARNING: THE MAINS PLUG OR AC INLET IS USED AS A DISCONNECT DEVICE. THE DISCONNECT DEVICE SHALL REMAIN READILY OPERABLE.</p> <p>WARNING: CONNECT ONLY TO MAINS SOCKET WITH PROTECTIVE EARTHING CONNECTION.</p> <p>WARNING: TO REDUCE THE RISK OF ELECTRIC SHOCK, DO NOT REMOVE COVER (OR BACK) AS THERE ARE NO USER-SERVICABLE PARTS INSIDE. REFER SERVICING TO QUALIFIED PERSONNEL.</p>		<p>The lightning flash with arrowhead symbol, within an equilateral triangle is intended to alert the user to the presence of uninsulated “dangerous voltage” within the product’s enclosure that may be sufficient magnitude to constitute a risk of electric shock to persons.</p>
		<p>The exclamation point within an equilateral triangle is intended to alert the user to the presence of important operating and maintenance (servicing) instructions in the literature accompanying the appliance.</p>
		<p>The asterisk within an equilateral triangle is intended to inform the user to necessary installation or removal instructions regarding equipment or hardware use relating to the system.</p>

1. Read and keep these safety instructions. Follow all instructions and heed all warnings.
2. Download the latest version of the applicable installation manual from www.electrovoice.com for installation instructions.



Information

Refer to the Installation Manual for instructions.

3. Follow all installation instructions and observe the following alert signs:



Notice!

Containing additional information. Usually, not observing a notice does not result in damage to the equipment or personal injuries.



Caution!

The equipment or the property can be damaged, or persons can be injured if the alert is not observed.



Danger!

Risk of electric shock.

4. **Clean only with dry cloth.** - Unplug the apparatus from the outlet before cleaning. Do not use liquid cleaners or aerosol cleaners.
5. **Condensation** - In order to avoid condensation; wait a few hours before turning on the equipment when it is transported from a cold to a warm space.
6. The apparatus shall not be exposed to dripping or splashing and no objects filled with liquids, such as vases, shall be placed on the apparatus.

**Danger!**

To reduce the risk of fire and electric shock, do not expose this apparatus to rain or moisture.

7. **Do not block any ventilation openings. Install in accordance with the manufacturer's instructions.** - Openings in the enclosure, if any, are provided for ventilation and to ensure reliable operation of the apparatus and to protect it from overheating. These openings must not be blocked or covered. This apparatus should not be placed in a built-in installation unless proper ventilation is provided or the manufacturer's instructions have been adhered to.
8. Do not install near any heat sources such as radiators, heat registers, stoves, or other apparatus (including amplifiers) that produce heat or in direct sunlight.
9. No naked flame sources, such as lighted candles, should be placed on the apparatus.
10. **Power cord options:**
 - **Mains plug**
 - Use a 3-pin mains plug that is registered with the Safety Authority.
 - Use a 2-pin mains plug that is certified¹ to EN 50075/IEC 60083 Standard C5 (shown in the Appendix S of Singapore Consumer Protection (Safety Requirements) Registration Scheme Information).
 - **Flexible cord**
 - Use a double insulated flexible cord that is certified¹ to the relevant IEC standards.
¹Certified by member of IECEE CB Scheme.
 - **Appliance connector**
 - Use an appliance connector certified¹ to IEC 60320.
¹Certified by member of IECEE CB Scheme.
11. **Do not defeat the safety purpose of the polarized or ground-type plug.** - A polarized plug has two blades with one wider than the other. A grounding type plug has two blades and a third grounding prong. The wider blade or the third prong are provided for your safety. If the provided plug does not fit into your outlet, consult an electrician for replacement of the obsolete outlet.
12. Mains powered equipment shall be connected to a mains power outlet socket with a protective earthing connection. An external, readily operable, mains plug or all-pole mains switch shall be installed.

**Caution!**

Grounded socket caution followed by translations into Danish, Finish, Norwegian and Swedish, as required by local regulations.

This device must be connected to a grounded socket.

Apparatets stikprop skal tilsluttes en stikkontakt med jord som giver forbindelse til stikproppens jord.

Laite on liitettävä suojakoskettimilla varustettuun pistorasiaan.

Apparatet må tilkoples jordet stikkontakt.

Apparaten skall anslutas till jordat uttag.

13. To completely disconnect AC power from this apparatus, the power supply cord must be unplugged.



Warning! To prevent a shock hazard disconnect all power sources prior to system installation.

14. Unplug the apparatus during lightning storms or when unused for long periods of time.
15. Protect the power cord from being walked on or pinched particularly at plug, convenience receptacles, and the point where they exit from the apparatus.



Danger!

Overloading - Do not overload outlets and extension cords as this can result in a risk of fire or electric shock.

16. **Only use attachments/accessories specified by the manufacturer.** - Any mounting of the apparatus should follow the manufacturer's instructions, and should use a mounting accessory recommended by the manufacturer.
17. **Use only with the cart, stand, tripod, bracket or table specified by the manufacturer, or sold with the apparatus.** - When a cart is used, use caution when moving the cart/apparatus combination to avoid injury from tip-over. Quick stops, excessive force, and uneven surfaces may cause the appliance and cart combination to overturn.
18. System installation and servicing by qualified personnel only, in accordance with applicable local codes. No user-serviceable parts inside.
19. Devices installed above 2 m height may cause injury when falling down. Preventive measures must be taken.
20. **Replacement parts** - When replacement parts are required, be sure the service technician has used replacement parts specified by the manufacturer or having the same characteristics as the original part. Unauthorized substitutions may result in fire, electric shock or other hazards.
21. Only replace the mains fuse of an apparatus with a fuse of the same type.
22. **Safety check** - Upon completion of any service or repairs to this apparatus, ask the service technician to perform safety checks to determine that the apparatus is in proper operating condition.



Warning!

This product is designed ONLY to be suspended with authorized Electro-Voice mounting accessories. Do NOT use non-authorized brackets or methods to suspend the loudspeaker. Handles on Electro-Voice loudspeakers are intended to only be used for temporary transport by people or for use with Electro-Voice authorized mounting accessories ONLY. Items such as fiber rope, wire rope, cables, or other types of materials cannot be used to suspend the loudspeaker from the handles.



Warning!

Use of non-authorized accessories or attachments with this or any Electro-Voice product is at your own discretion. Use of non-authorized accessories or attachments can result in product malfunction, injury, or death.

The user assumes all liability and may result in the warranty being voided.



Caution!

Do not attempt to move this loudspeaker system when it is fully assembled. You may damage the system or cause personal injury.

1.2 Precautions

- If an Electro-Voice loudspeaker is used outdoors on a sunny day, place the loudspeaker in a shaded or covered area. The loudspeaker amplifiers have protection circuits that temporarily shut the loudspeaker off when extremely high temperatures are reached. This can happen on hot days when the loudspeaker is in direct sunlight.
- Do not use Electro-Voice loudspeakers in an environment where temperatures are below 0°C (32°F) or exceed +35°C (95°F).
- Electro-Voice loudspeakers are easily capable of generating sound pressure levels sufficient to cause permanent hearing damage to anyone within normal coverage distance. Caution should be taken to avoid prolonged exposure to sound pressure levels exceeding 90 dB. To prevent hearing damage do not listen at high volume levels for long periods.

1.3 Suspension



Warning!

Suspending any object is potentially dangerous and should only be attempted by individuals who have a thorough knowledge of the techniques and regulations of suspending objects overhead. Electro-Voice strongly recommends all loudspeakers be suspended taking into account all current national, federal, state, and local laws and regulations. It is the responsibility of the installer to ensure all loudspeakers are safely installed in accordance with all such requirements. When loudspeakers are suspended, Electro-Voice strongly recommends the system be inspected at least once per year or as laws and regulations require. If any sign of weakness or damage is detected, remedial action should be taken immediately. The user is responsible for making sure the wall, ceiling, or structure is capable of supporting all objects suspended overhead. Any hardware used to suspend a loudspeaker not associated with Electro-Voice is the responsibility of others.



Warning!

Do not suspend this product in any other manner than explicitly described in this manual, or Electro-Voice installation guides. Suspending any object (loudspeaker) is potentially dangerous and should only be done by individuals with thorough knowledge of techniques, materials, and regulations for suspending objects overhead. Electro-Voice loudspeakers can only be suspended using accessories and hardware described in Electro-Voice manuals and installation guides. **Do NOT use handles to suspend the loudspeaker. Handles on Electro-Voice loudspeakers are intended to only be used for temporary transport by people. Items, such as fiber rope, wire rope, cables, or other types of materials cannot be used to suspend loudspeaker from the handles.** Any hardware used to suspend a loudspeaker not associated with Electro-Voice is the responsibility of others.



Warning!

Use of non-authorized accessories or attachments with this or any Electro-Voice product is at your own discretion. Use of non-authorized accessories or attachments can result in product malfunction, injury, or death.

The user assumes all liability and may result in the warranty being voided.

2 Product registration



Register your EVOLVE: electrovoice.com/register

3 Short information

This document is applicable to these products:

CTN	Description
EVOLVE70-90-TB	EVOLVE70-90 Column, pole black
EVOLVE70-SB-US	EVOLVE 15" Sub Black US cord
EVOLVE70-SB-EU	EVOLVE 15" Sub Black EU cord
EVOLVE90-SB-US	EVOLVE 18" Sub Black US cord
EVOLVE90-SB-EU	EVOLVE 18" Sub Black EU cord
EVOLVE70-90-TW	EVOLVE70-90 Column, pole white
EVOLVE70-SW	EVOLVE 15" Sub White US & EU
EVOLVE90-SW	EVOLVE 18" Sub White US & EU
EVOLVE70-90-PL-SB	EVOLVE70-90 Short Pole Black
EVOLVE70-90-PL-SW	EVOLVE70-90 Short Pole White
EVOLVE70-CVR	EVOLVE70 Sub slip cover
EVOLVE90-CVR	EVOLVE90 Sub slip cover
EVOLVE70-DOLLY	EVOLVE70 Dolly
EVOLVE90-DOLLY	EVOLVE90 Dolly

3.1 Parts included

Make sure that all parts are included and not damaged. If the packaging or any parts are damaged, contact your shipper. If any parts are missing, contact your Sales or Customer Service Representative.

EVOLVE70-SB-US, EVOLVE70-SB-EU, EVOLVE70-SW, EVOLVE90-SB-US, EVOLVE90-SB-EU, EVOLVE90-SW

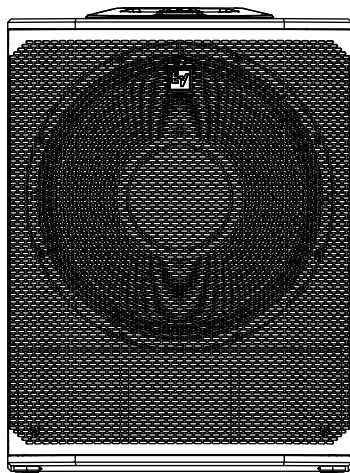

x1

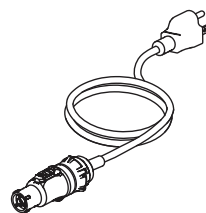

x1



x1



x2

Quantity	Component
1	Subwoofer
1 ^{1,2}	Power cord
1	Quick user guide
2	Safety and security information

¹ EVOLVE70-SW and EVOLVE90-SW include two power cords.

² US and EU power cords available in selected countries. Contact your nearest Electro-Voice dealer or Electro-Voice distributor for more information.

EVOLVE70-90-TB, EVOLVE70-90-TW

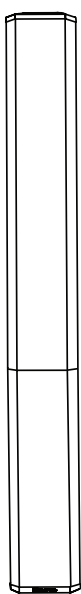

x1



x1

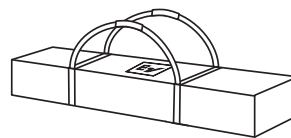

x1

Quantity	Component
1	Column array
1	Sub pole
1	Carry bag

4 Description

Thank you for choosing an Electro-Voice portable column system. Please take time to consult the manual to understand all the features built into your EV system and fully utilize its performance capabilities.

EVOLVE 70 and EVOLVE 90 expand the EVOLVE Column Loudspeaker system family. This addition delivers the EVOLVE’s audio performance, portability and ease of assembly in a larger format, catering to the evolving needs of professional users including pro DJs, bands, production companies, event organizers, and venues.

EVOLVE 70 and EVOLVE 90 feature 15-inch and 18-inch subwoofers, designed to provide deeper bass and optimum sound quality for events with 300 to 500 attendees or more.

Building on the success and renowned audio quality of the EVOLVE 50, EVOLVE 70 and EVOLVE 90 embody a premium solution that combines portability and a relatively compact form factor with massive output, waveguide-formed coverage and longer throw for bigger shows/events.

EVOLVE 70 and EVOLVE 90 are integrated into the QuickSmart Mobile App ecosystem, which allows the user to control it as part of a system with other Bluetooth®-enabled Electro-Voice portable speakers.

EVOLVE 70 and EVOLVE 90 feature industry standard connectors for microphones and line-level signals, including XLR/TRS combo jacks, stereo RCA line input, AES/EBU digital audio, and Bluetooth® true wireless stereo streaming.

Available in black or white finishes.

Accessories

The EVOLVE family includes a select complement of accessories.





CTN	Description
EVOLVE70-90-PL-SB	EVOLVE70-90 Short Pole Black
EVOLVE70-90-PL-SW	EVOLVE70-90 Short Pole White
EVOLVE70-CVR	EVOLVE70 Sub slip cover
EVOLVE90-CVR	EVOLVE90 Sub slip cover
EVOLVE70-DOLLY	EVOLVE70 Dolly
EVOLVE90-DOLLY	EVOLVE90 Dolly

- **Short distance pole** - to be used when the EVOLVE system is placed in an elevated surface such as a stage. The short distance pole reduces the system height by 445 mm (17.5 in).
- **Padded slip cover** - to be used either on its own, or with the dolly. It provides protection for the subwoofer to allow for use as a stacking surface. For example, it is possible to set the column on top of the subwoofer when it is on the dolly and roll it in and out of a venue.
- **Dolly board with casters for subwoofers** - specific for EVOLVE 70 and EVOLVE 90 subwoofers.

4.1 Quick setup

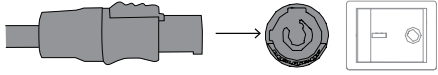
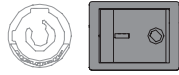
To set up the loudspeaker:

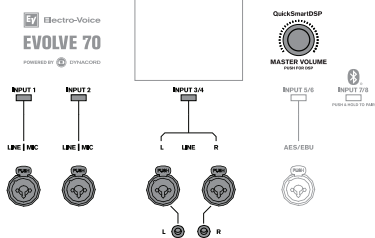
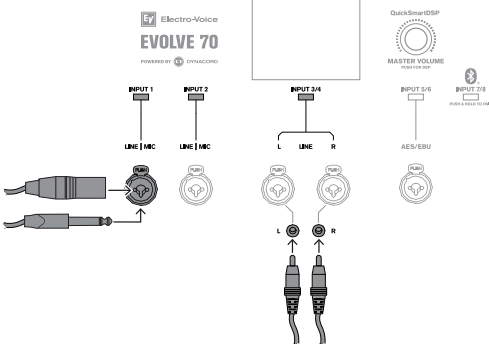
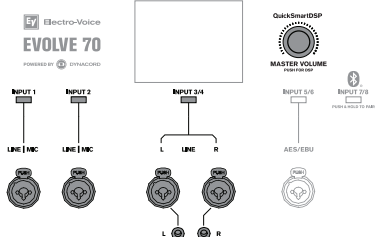
Step	Illustration
------	--------------

<p>1. Connect the AC power cord from a grounded receptacle to the MAINS IN.</p>	
<p>2. Switch power to ON.</p>	
<p>3. Adjust the volume (VOL) to 0 dB using the MASTER VOLUME knob.</p>	
<p>4. Press the input selection soft key to select the input channel. The soft key will illuminate once selected.</p> <p>5. Use the MASTER VOLUME knob to adjust INPUT LEVEL to MUTE.</p>	
<p>6. Connect an audio source using appropriate XLR, TRS, or RCA (cinch) cables. Ensure audio source is MUTE or at a low level before making connection. After connection is made, increase the source's output to a reasonable level.</p>	
<p>7. Adjust the INPUT LEVEL until the signal peaks are just below maximum level or the required output is achieved. If PK is indicated, turn the level down until the PK indication disappears.</p> <p>8. Press the input selection soft key again to exit the channel menu.</p>	
<p>9. Using the MASTER VOLUME knob, adjust the volume (VOL) until you get the required output from the loudspeaker.</p>	

5 Installation



Caution!

Do not attempt to move this loudspeaker system when it is fully assembled. You may damage the system or cause personal injury.

Assembling the loudspeaker system

To **assemble the loudspeaker system**, do the following:

1. Place the **subwoofer** on a level and stable surface.
2. Insert the pole into the subwoofer base.
The pole has magnets (A) at each end.
3. Place the **column array loudspeaker system** on top of the subwoofer pole.
4. The **column array loudspeaker system** set up is complete.

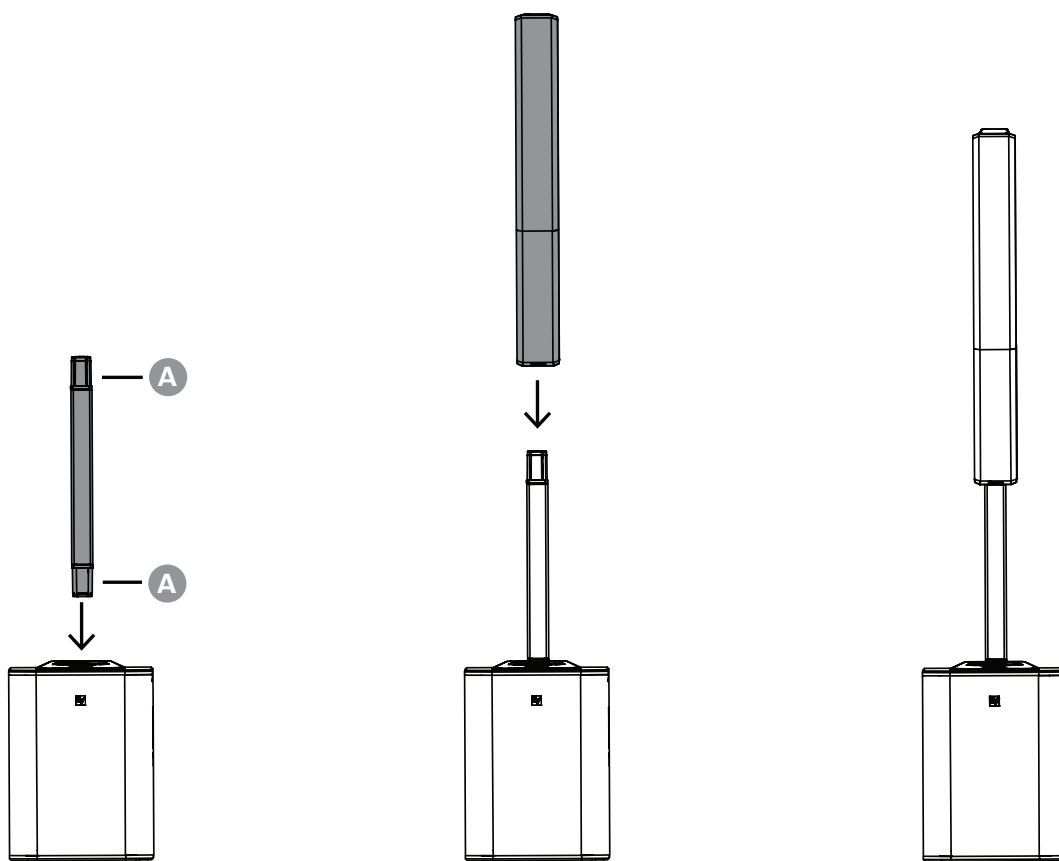

6 Pairing the QuickSmart Mobile application

The EV QuickSmart Mobile app for tablets and smartphones is available for download from the Apple App Store and the Google Play Store.

Download and check the app for the latest firmware updates to enjoy optimal audio performance and maximize your control of the system.



Notice!

The EV QuickSmart Mobile app is designed to only find loudspeakers from Electro-Voice featuring Bluetooth® control functionality.

The EV QuickSmart Mobile app will not display other types of Bluetooth® devices, e.g. phones, laptops, tablets, or headsets.

Prior to pairing the EV QuickSmart Mobile app with Electro-Voice loudspeakers:

1. Ensure that Bluetooth® is enabled on the smartphone or tablet.
2. Ensure that pairing mode is enabled on the loudspeaker.

To place the loudspeaker in pairing mode for both control and streaming:

1. Press and hold **INPUT 7/8** until **Pairing Mode On** and the 4-digit ID is shown on the LCD. Pairing mode can be enabled through the LCD menu for control and streaming separately. The loudspeaker remains in control pairing mode for about 2 minutes. If control pairing fails, repeat this step.
2. Navigate to your mobile device's Bluetooth® settings menu, find the EVOLVE loudspeaker with the matching 4-digit ID and ensure you are paired to the loudspeaker. This will pair the mobile device to the EVOLVE loudspeaker for audio streaming.
3. Continue to the next step to pair for control.



Notice!

For Android devices running Android version 11 or older, ensure location services are allowed. Electro-Voice does not collect, store, or track user location data or personal information.

First time pairing

1. Open the EV QuickSmart Mobile app. 
2. **Select your Speakers** is displayed on the screen. The EV QuickSmart Mobile app is looking for available Bluetooth® enabled Electro-Voice loudspeakers. The available loudspeakers are displayed on the screen.
3. Tap the loudspeaker you want to pair with the app. The selected loudspeaker will have a line under it acknowledging it is selected.
4. Repeat the previous step until all of the required loudspeakers are selected.
5. Tap the **CONNECT** button.
6. The app connects with the selected loudspeaker. You will get a message from iOS/iPadOS/Android about pairing for each device which has to be accepted.



Notice!

If the message "Bluetooth Connection failed" appears, ensure that control pairing mode is enabled in the loudspeaker.

7. Tap **PAIR** on the device to accept pairing to the loudspeakers. The app can connect to up to six loudspeakers.

Subsequent pairing

To pair additional loudspeakers with the EV QuickSmart Mobile app:

1. Tap the EV QuickSmart Mobile app icon. 
2. **Select your Speakers** is displayed on the screen.
The EV QuickSmart Mobile app is looking for available Bluetooth® enabled Electro-Voice loudspeakers.
The available loudspeakers are displayed on the screen.
3. Tap the loudspeaker you want to pair with the app.
The selected loudspeaker will have a line under it acknowledging it is selected.
4. Repeat the previous step until all of the required loudspeakers are selected.
5. Tap the **CONNECT** button.
The app connects with the required loudspeaker.
The app can connect to up to six loudspeakers.

7 Amplifier DSP

7.1 Amplifier DSP controls

The amplifier has a combination of controls and connectors to ensure the most versatile loudspeaker system.

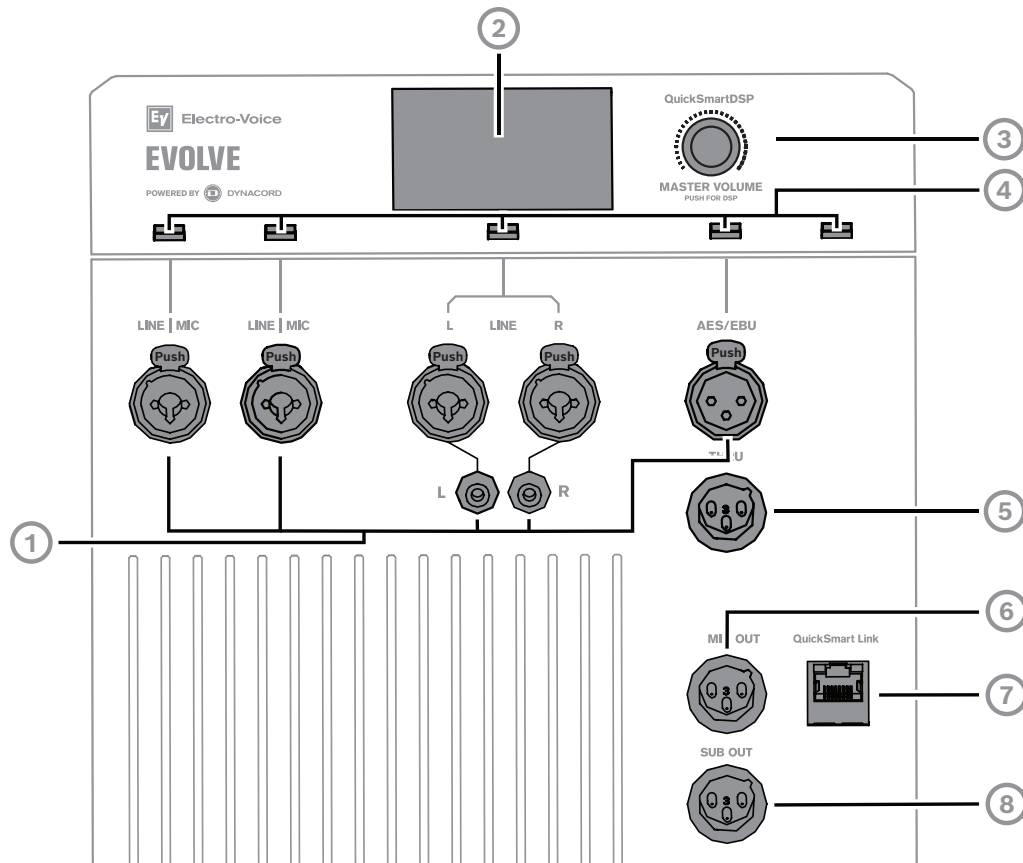

1. INPUT connectors

- **INPUT 1 and INPUT 2** - Balanced INPUT for the connection of signal sources like instruments, or microphones. Connections can be established using TRS or XLR connectors. The XLR connectors for INPUT 1 and INPUT 2 are separately switchable for 48V phantom power.
- **INPUT 3/4** - Stereo INPUT 3/4 for connection of stereo line level signals of sources like mixing consoles or DJ controllers. Connection is made using either two XLR-type, TRS, or RCA.
- **INPUT 5/6 AES/EBU** - Professional digital audio interface accepting AES/EBU (Audio Engineering Society/European Broadcasting Union), AES3 or S/PDIF (with adapter cable) from mixing consoles, DJ controllers and other devices, and sample rates between 32 kHz and 192 kHz.



Notice!

Only cables specified for digital signals with an impedance of 110 Ohms are recommended for AES3.

- **INPUT 7/8** - Stereo Bluetooth audio connection.

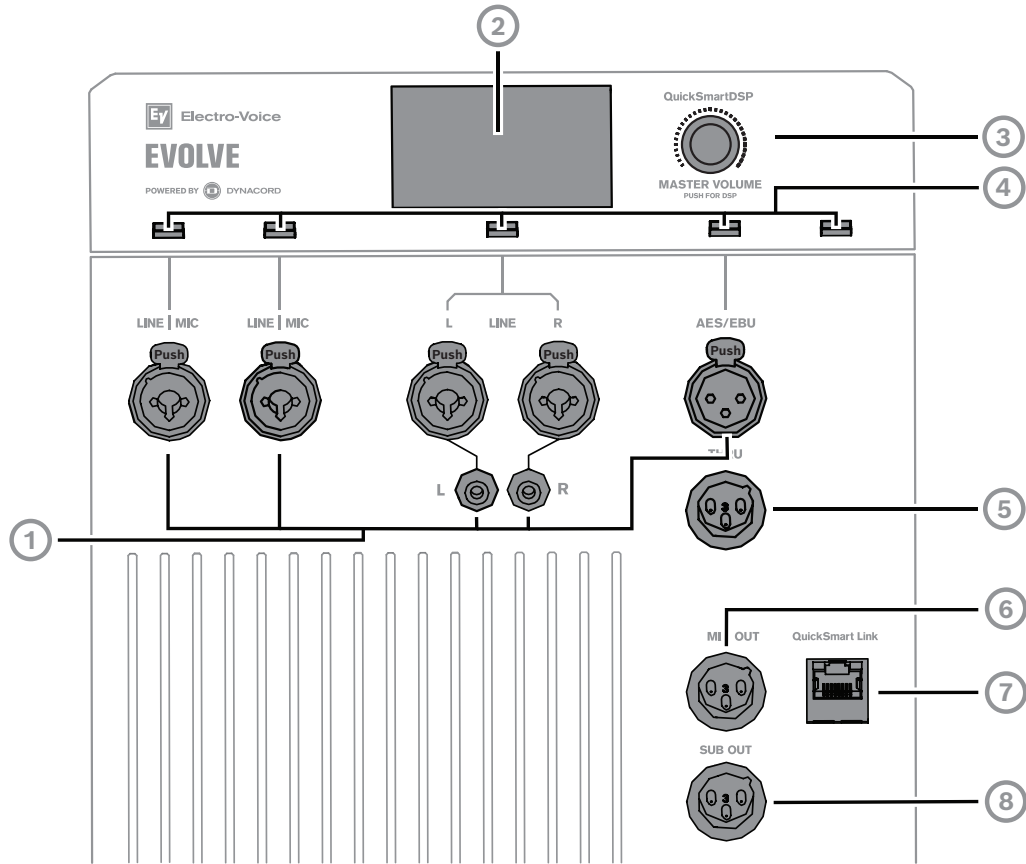

2. **LCD** – DSP control and monitoring interface.
3. **MASTER VOLUME** - Adjusts the sound level and navigates the DSP control menu.
DSP - Scroll through the menu and select the available choices. Push the **MASTER VOLUME** knob to enter the DSP control menu.
4. **Input selection soft keys** - Press the soft key to select the input and access the DSP control menu for the channel. Press the softkey a second time to deselect the channel and return to the main DSP.
5. **THRU** - Buffered thru signal from AES/EBU input.
6. **MIX OUT** - The post-fader audio signals of INPUT 1 through INPUT 7/8 are mixed and passed to MIX OUT. When the level controls of INPUT 1 - INPUT 7/8 are adjusted, the volume change will be reflected at MIX OUT. This feature allows the loudspeaker to act as a basic eight-channel mixer that can send the mix to another loudspeaker via the MIX OUT socket. The output is configurable in the menu to provide either the Mixer Mono, Stereo left or Stereo right signal. If QuickSmart Link is used, MIX OUT provides the same signal as the local column system.
7. **QuickSmart Link** - RJ45 connector for Cat5 cable to link two EVOLVE systems together for digital audio and system control. The maximum recommended cable length is 100 m (328 ft).



Notice!

QuickSmart Link should only be used to connect two EVOLVE systems. QuickSmart Link is not an Ethernet/LAN port and is not compatible with network devices.

8. **SUB OUT** - Intended to connect additional EVOLVE powered subwoofer cabinets or other subwoofers. The SUB OUT provides the full MAIN mix of the system and is configurable as PRE or POST System Volume, System Delay and Subwoofer Delay.

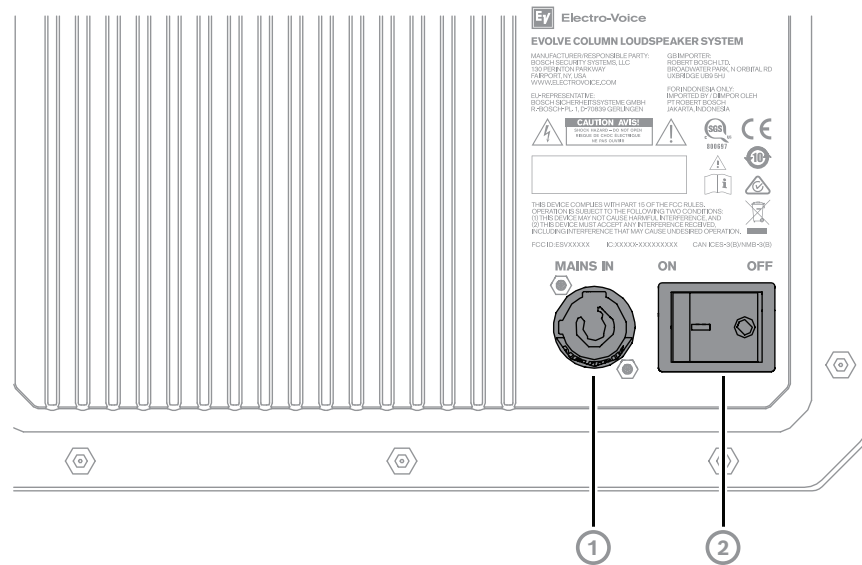

1. **MAINS IN** - The device receives its power supply via the MAINS IN socket. Only the provided power cord may be used. Connect the device only to a mains network that can handle 100 - 240 V AC, 50 - 60 Hz. AC connection is established via a twist-locking powerCON® power input connector.
 - Insert the connector and twist it clockwise until it is locked. You will hear a click.



Notice!

To remove the twist-locking powerCON® power input connector, pull the lever back, twist it counter-clockwise and pull out.

2. **POWER** - Switch for power **ON** or **OFF** of the loudspeaker. The LCD screen lights up when the power is turned **ON**, after approximately three seconds.

7.2 System status

Normal

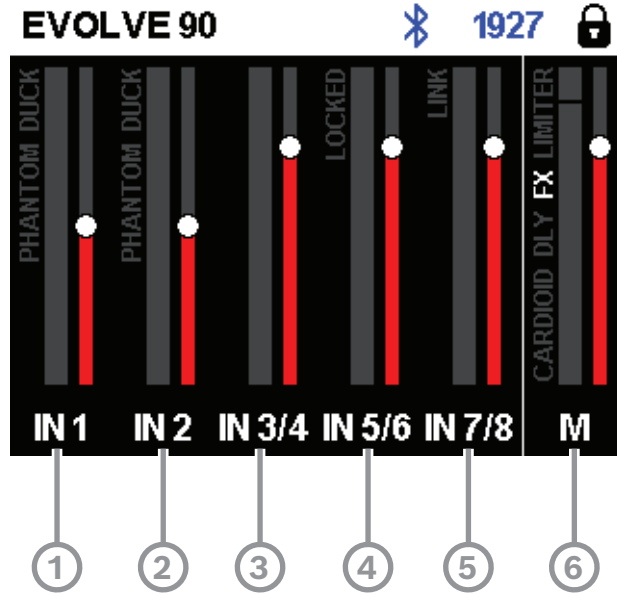

1. **IN 1** - VU meter displays the signal level of INPUT 1 into the amplifier INPUT 1 connector.
 - The display of **PHANTOM** indicates 48V phantom power is switched on.
 - The display of **DUCK** indicates that the ducker feature was enabled on this channel to reduce all stereo input signals when INPUT 1 signal exceeds the configured threshold.
2. **IN 2** - VU meter displays the signal level of INPUT 2 into the amplifier INPUT 2 connector.
 - The display of **PHANTOM** indicates 48V phantom power is switched on.
 - The display of **DUCK** indicates that the ducker feature was enabled on this channel to reduce all stereo input signals when INPUT 2 signal exceeds the configured threshold.
3. **IN 3/4** - VU meter displays signal level of INPUT 3/4 into the amplifier INPUT 3/4 connector (maximum of left and right signal).
4. **IN 5/6** - VU meter displays signal level of INPUT 5/6 AES/EBU into the amplifier INPUT 5/6 AES/EBU connector (maximum of left and right signal). The display of **LOCKED** indicates a valid AES/EBU, AES3 or S/PDIF signal was detected.
5. **IN 7/8** - VU meter displays signal level of incoming Bluetooth audio signal (maximum of left and right signal).
 - The display of **LINK** indicates an active TWS (True Wireless Stereo) audio connection with another TWS speaker such as EVOLVE 70/90, EVERSE 8/12 or ZLX-G2.
6. **M** - VU meter displays the signal level of the main speaker output.
 - The display of **DLY** indicates that a system delay was set for this speaker (up to 100 meters / 328.1 feet).
 - The display of **CARDIoid** indicates that the subwoofer is used as cardioid speaker together with the main column system. The signal to the pole connector for the column is disabled in this mode.

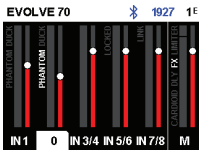

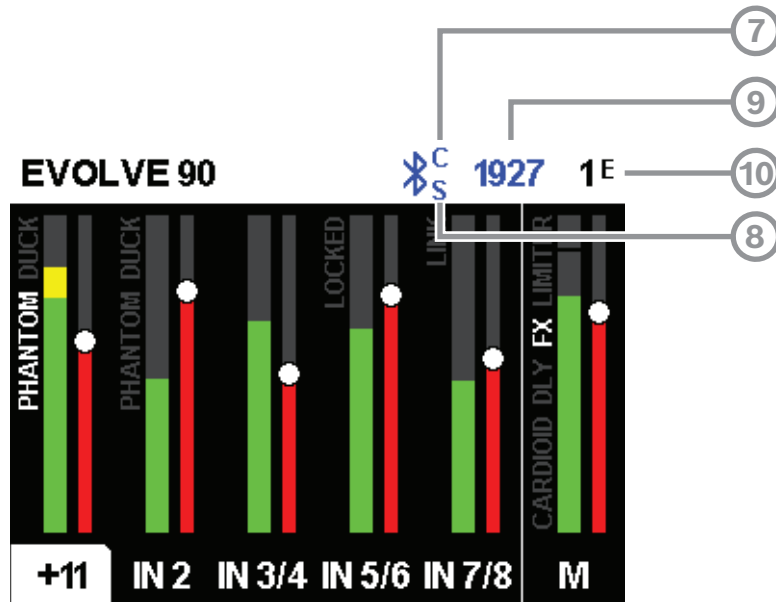

7. **C** - Bluetooth control app. The available options are:
 - Off - disabled
 - Flashing - pairing mode
 - Solid - connected
8. **S** - Bluetooth audio streaming. The available options are:
 - Off - disabled
 - Flashing - pairing mode (120s)
 - Solid - connected
9. Loudspeaker 4-digit ID to pair via Bluetooth®.
10. **Status display** - Alternately shows the following:
 - 1** - Indicates the selected preset number. There are five user-defined presets and one factory default preset available.
 - E** - Edited. Indicates the preset is not saved. When the preset is saved, the **E** is not displayed.
 - Lock status** - Indicates that the LCD display and controls are locked. Press the **MASTER VOLUME** knob or channel select soft key to unlock.

System protection

System protection limiters indicate when a system is exceeding recommended usage by showing:

- PK
- CLIP
- LIMITER
- AMP HOT!

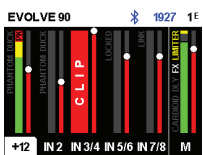

Notice!

Older firmware versions show **PEAK** instead of **CLIP**.

PK

PK indicates that the audio source signal to the loudspeaker reached the maximum input level, also called PEAK limit: -3 dB. This may result in a clipped signal causing audio distortion and potential damage to the equipment.

If **PK** is shown:

- ▶ Reduce the **INPUT GAIN** or the audio source signal.
- If **PK** stays active for more than 1 second, the system shows **CLIP**.

CLIP

CLIP indicates that the audio source signal exceeded the maximum input level and is producing audio distortion. This results in rough and harsh audio output and can cause damage to the equipment.

If **CLIP** is shown:

- ▶ Reduce the **INPUT GAIN** and/or the audio source signal until **CLIP** stops showing.

LIMITER

LIMITER protects the loudspeaker from short-term peaks and long-term overload, which can cause distortion. When **LIMITER** is displayed on the screen, the limiter is active.

If the **LIMITER** indication is shown often or continuously:

- ▶ Reduce the output volume (**MASTER VOLUME**). This is strongly recommended.

AMP HOT!

AMP HOT! indicates that the amplifier has heated up to a point where the loudspeaker will cut out or shut down.

If **AMP HOT!** is shown:

- ▶ Make sure the system is not in direct sunlight or near another heat source.
- ▶ Ensure that the system’s airflow is not obstructed and that the rear panel is not covered.
- ▶ If possible, switch off the system and give it time to cool down.

After cooling down, if the system still displays **AMP HOT!**, contact your Sales or Customer Service Representative.

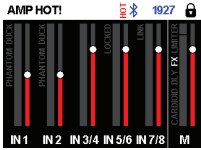

7.3

DSP control menu

An integrated DSP control menu allows the user to select multiple DSP system settings on the loudspeaker.

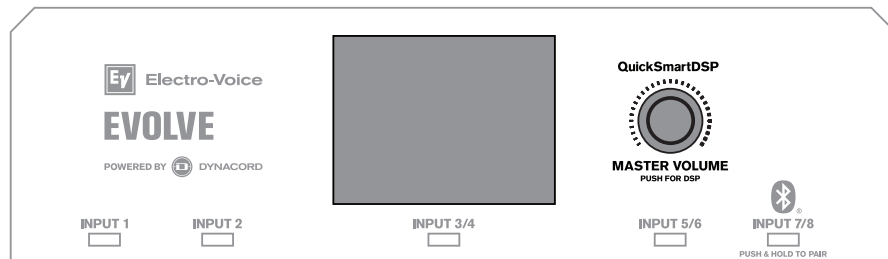

Accessing the DSP control menu

To access the DSP control menu:

1. Push the **MASTER VOLUME** knob.
The DSP control menu appears.
2. Using the **MASTER VOLUME** knob, scroll through the menu items.

3. Push the **MASTER VOLUME** knob to select the menu item you want to modify.
The focus moves to the parameters on the right side of the DSP control menu.
4. Using the **MASTER VOLUME** knob, scroll through the parameters.
5. Push the **MASTER VOLUME** knob to confirm the selected parameter.
The setting is saved. The focus returns to the menu items on the left side of the DSP control menu.
6. Repeat steps 2 through 5 to modify additional DSP and system settings.
7. Select **EXIT** to return to the home screen.

7.3.1

Loudspeaker DSP control menu

The loudspeaker DSP control menu selections are available for the EVOLVE loudspeakers. Refer to *OUTPUT list*, page 50 for the complete menu list.

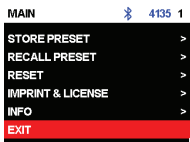

EXIT menu

The **EXIT** menu is used to return to the home screen.



Notice!

The display returns to the home screen after 30 seconds of inactivity.

SUB CONFIG

The **SUB CONFIG** control is used to configure the operation mode of the subwoofer.

- **NORMAL** - The subwoofer is used with a column speaker attached as a full range system.
- **CARDIOD** - The subwoofer is connected on the **SUB OUT** connector of an EVOLVE 70/90 system to reduce the low frequency radiation behind the system. On this mode the subwoofer is placed besides the system subwoofer and turned backwards. The pole connector for the column is deactivated in this mode.

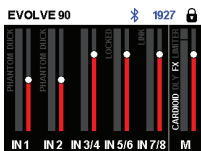

For more information on how to set up **CARDIOD** configuration, refer to *Stereo with cardioid subwoofer*, page 37.

MODE menu

The **MODE** menu is used to configure the type of sound the loudspeaker delivers.

Available options for this selection are: **MUSIC**, **LIVE**, **SPEECH** and **CLUB**.

- **MUSIC** - is used for recorded music playback.
- **LIVE** – is used for live sound applications.
- **SPEECH** – is used for spoken word applications.
- **CLUB** - is used for recorded electronic music playback when more bass response is desired.

The default is **MUSIC**.

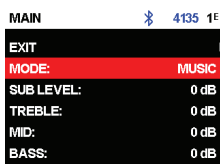

SUB LEVEL

The **SUB LEVEL** control is used to adjust the volume of the subwoofer. The column is not affected by this setting.

The default is **0 dB**.

TREBLE control

The **TREBLE** control is used to adjust the high frequency performance of the loudspeaker for different applications or personal preference. The parameter controls a high shelving filter.

The default is **0 dB**.

MID control

The **MID** control is used to adjust the midrange frequency performance of the loudspeaker for different applications or personal preference.

The default is **0 dB**.

BASS control

The **BASS** control is used to adjust the low frequency performance of the loudspeaker for different applications or personal preference. The parameter controls a low shelving filter.

The default is **0 dB**.

MAIN GEQ menu (default)

The **MAIN GEQ** menu is used to adjust the frequency response of the loudspeaker for different applications or personal preference. There are seven different EQ filters available centered at the following frequencies: 63, 160, 400, 1.0K, 2.5K, 6.0K & 12K Hz.

The range of each filter is -12 dB to +12 dB.

The default value for each filter is **0 dB**.

MAIN PEQ menu

The **MAIN PEQ** menu is used to adjust the frequency response of the loudspeaker for different applications or personal preference. There are seven equalization filters available.

The filter type is selectable between the following:

PEQ - Parametric Equalization Filters shape the sound using peak/dip bell shaped filters which have three controls.

- **Q** - Quality Factor defines the bandwidth of the filter. A lower **Q** provides a wider bandwidth and a higher **Q** provides a narrower bandwidth.
- **FREQ** - selects the center frequency of the EQ filter.
- **GAIN** - sets the amount of increase or reduction of the equalization filter.

LOW/HI SHELF - Shapes the sound using a shelving type filter that can be applied to the low frequency or high frequency response using two controls:

- **FREQ** - sets the center frequency of the filter. For the **LOW SHELF** filter the **GAIN** of the filter tapers off above the frequency selected. For the **HIGH SHELF** filter the **GAIN** of the filter tapers off below the frequency selected.
- **GAIN** - sets the amount of increase or reduction of the signal below or above the **FREQ** setting.

LOW/HI PASS - Pass band filters that shape the sound by only passing signal above or below the selected frequency.

- **FREQ** - sets the corner frequency for the pass band filter. For **HI PASS** filters all frequencies above the selection will be passed through. Frequencies below the setting will be tapered off. For **LOW PASS** filters all frequencies below the selection will be passed through. Frequencies above the selection will be tapered off.

FX & FX ENABLE

The **FX** control is used to select the desired effect (e.g. reverb, chorus, delay, etc.) to apply to the FX send. The FX send level is independently controlled in the INPUT 3/4 FX control. The **FX ENABLE** turns **ON** or **OFF** the effect globally.

MIX OUT menu

The **MIX OUT** menu is used to select which signal(s) should be output at **MIX OUT** and which signal should be delivered by the loudspeaker.

- **L+R** - The left and right signals of all inputs are summed. The sum is output at **MIX OUT** and is delivered by the loudspeaker (default).
- **L** - Only the panned left signal of all inputs is output at **MIX OUT**. The loudspeaker will deliver only the right signal.
- **R** - Only the panned right signal of all inputs is output at **MIX OUT**. The loudspeaker will deliver only the left signal.

SPK OUT menu

The **SPK OUT** setting configures the signal sent to the speaker itself.

- QuickSmart Link connected - **SPK OUT** and **MIX OUT** signals are identical (L+R/L/R).
- No QuickSmart Link connected - **SPK OUT** and **MIX OUT** signals are contrary (L/R) or also identical in case of mono system (L+R).

BLUETOOTH menu

The **BLUETOOTH** menu is used to set the Bluetooth® functionality of the loudspeaker.

ON/OFF - The **ON/OFF** menu controls whether Bluetooth® functionality is enabled or disabled on the loudspeaker.

CONTROL PAIR - The **CONTROL PAIR** menu is used to enable the QuickSmart Mobile app wireless control and monitoring application. Available options for this selection are: **ON** or **OFF**.

The default is **OFF**.

AUDIO PAIR - The **AUDIO PAIR** menu is used to stream audio from your Bluetooth® enabled device to the loudspeaker system. Available options for this selection are: **PAIRING**, **ON** or **OFF**.

The default is **OFF**.

LINK SPEAKERS

The **LINK SPEAKERS** function allows two EVOLVE loudspeakers to be linked over Bluetooth® in true wireless stereo for Bluetooth® audio streaming only.

To link two EVOLVE loudspeakers:

1. Pair one of the EVOLVE loudspeakers via Bluetooth® to a mobile device. Refer to Pairing the QuickSmart Mobile app for pairing instructions.
2. In both EVOLVE loudspeakers, navigate to the **BLUETOOTH** menu in the Main DSP menu.
3. In both EVOLVE loudspeakers, select **LINK SPEAKERS**.
The LCD display will show **LINKING SPEAKERS...** while establishing connection between both EVOLVE loudspeakers. When the connection is established, the menu will display **UNLINK SPEAKERS**.
In the **BLUETOOTH** menu below **LINK SPEAKERS**, the stereo channel selection will appear.
4. Select the appropriate stereo channel selection for each EVOLVE loudspeaker: **L+R** (mono), **L**, or **R**.

Note: This is stereo image from the audience's perspective, also known as House L & R.

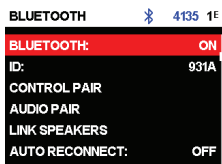



Notice!

With Bluetooth true wireless stereo (TWS) a mobile device can stream an audio signal to two loudspeaker systems. It is not possible to send input signals or the Mix of one EVOLVE to another EVOLVE system with this feature.

AUTO RECONNECT

The **AUTO RECONNECT** function allows to automatically connect your EVOLVE to your audio streaming device when paired before. Both are switched on and Bluetooth is enabled. Available options for this selection are: **ON** or **OFF**.

The default is **OFF**.

LED menu

The **LED** menu shows power on and indicates limit. Available options for this selection are: **ON**, **OFF** or **LIMITER**.

- **ON** - turns the LED on when the power switch is set to ON.
- **OFF** - turns the LED off.
- **LIMITER** - turns the LED off under normal operation. The LED brief blinking indicates the limiter is activating. Short-term blinking is not critical because the integrated limiter keeps distortion under control. Constant lighting of the LED indicates the sound is negatively affected. If the LED is constantly lit, check the rear LCD for more information. Reducing the output volume is strongly recommended.

The default is **ON**.

PIN LOCK menu

The **PIN LOCK** menu locks the DSP control menu. Available options for this selection are: **OFF**, **TUNE** or **ALL**.

- **OFF** - turns the **PIN LOCK** off.
- **TUNE** - locks the **INPUT** control parameters but not the DSP control menu.
- **ALL** - locks all functions of the speaker.

The default is **OFF**.

To lock the DSP control menu:

1. Select **TUNE** or **ALL**.
2. Enter a PIN code.
3. Re-enter the PIN code to confirm.
If the PIN code does not match, it will set the **PIN LOCK** to **OFF**.
4. To lock the speaker select **LOCK NOW** from the **DISPLAY** menu.

The **PIN LOCK** will automatically engage after the speaker is power cycled.

To disable the **PIN LOCK**:



1. If not done already, unlock the device by entering the PIN code.
2. Deselect any input selection soft keys.
3. Push the **MASTER VOLUME** knob.
4. Using the **MASTER VOLUME** knob, scroll to **DISPLAY**.
5. Select **PIN LOCK**.
6. Select **OFF**.

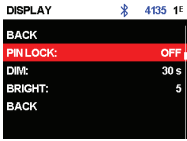

If you forget the PIN code, reset the loudspeaker to default settings.

To reset the loudspeaker to default settings:

- ▶ Press and hold the soft key for **INPUT 2** and **MASTER VOLUME** knob for at least 15 seconds. The **DEFAULT SETTINGS?** message appears.
- ▶ Select **YES**. The **ERASE USER PRESETS?** message appears.
- ▶ Select **NO**.

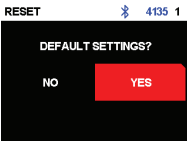

DIM menu

The **DIM** menu is used to dim the display when the display is idle for the configured time. Available options for this selection are: **OFF, 10 to 60 seconds**.

The default is **30 seconds**.

BRIGHT menu

The **BRIGHT** menu is used to determine the brightness of the LCD.

The range is 1 (darkest) to 10 (brightest).

The default is **5**.

STORE menu

The **STORE** menu allows you to create up to five customized user settings. Available options for this selection are: **BACK, 1, 2, 3, 4, and 5**.



Notice!

The customized user setting name can contain a combination of alphanumeric characters including spaces. The alphanumeric character range is A to Z and 0 - 9.

The name field length is 12 characters.

Storing customized user settings

To store customized user settings:

1. From the DSP control menu, scroll to **STORE**.
2. Push the **MASTER VOLUME** knob to select **STORE**. The **STORE** screen appears.
3. Push the **MASTER VOLUME** knob to select **1**. The **Enter name for 1** screen appears.
4. Use the **MASTER VOLUME** knob to scroll through the characters. The characters appear.
5. Push the **MASTER VOLUME** knob to select the required character.
6. Turn the **MASTER VOLUME** knob to move to the next character entry. Continue selecting characters until the required name is entered.

7. Use the **MASTER VOLUME** knob to scroll to **SAVE**.
8. Push the **MASTER VOLUME** knob to select **SAVE**.
9. Repeat steps 3 through 8 to store additional customized user settings.
10. Select **EXIT** to return to the home screen.

RECALL menu

The **RECALL** menu allows you to retrieve up to five customized user settings. Available options for this selection are: **BACK**, **1**, **2**, **3**, **4**, and **5**. In addition, setting **6** is available to recall a default setting. This setting cannot be used to store user settings.

Recalling customized user settings

To recall customized user settings:

- ▶ From the DSP control menu, scroll to **RECALL**.
- ▶ Push the **MASTER VOLUME** knob to select **RECALL**.
The **RECALL** screen appears.
- ▶ Push the **MASTER VOLUME** knob to select **1**.
The selected item is loaded.
- ▶ After the preset is loaded, the menu will return to the home screen.

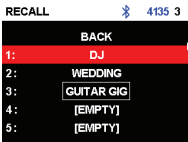

RESET menu

The **RESET** menu is used to reset the loudspeaker to original factory settings. Available options for this selection are: **NO** or **YES**.

Resetting the system

To reset the system to original factory settings:

- ▶ From the DSP control menu, select **RESET**.
The **DEFAULT SETTINGS?** message appears.
- ▶ Select **YES**.
The **ERASE USER PRESETS?** message appears.
- ▶ Select **YES**.

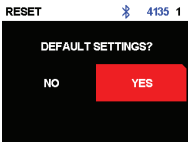

Notice!

The **RESET** menu item is used to revert the loudspeaker to the original factory default settings.

INFO menu

The **INFO** menu is used to display the firmware version.

Refer to

- *OUTPUT list*, page 50
- *Stereo with cardioid subwoofer*, page 37

8 Input & Mixer operation

8.1 INPUT DSP control menu

The loudspeaker INPUT DSP control menu selections are available for the EVOLVE powered loudspeakers.

Refer to *INPUT list*, page 53 for the complete menu list.

To control the mixer channels:

1. Press the input selection soft key to select the input channel.
The softkey will illuminate once selected.
2. Use the **MASTER VOLUME** knob to adjust the level.
3. Press the **MASTER VOLUME** knob to enter the input channel's DSP control menu.
4. Press the input selection soft key again to deselect the input channel for control.
The soft key will no longer be illuminated.

INPUT control adjustments

Caution is advised when adjusting the **INPUT LEVEL** and EQ. Usually minor changes are sufficient to produce the best results in the overall sound.

To adjust the incoming sound:

- Set all EQ controls to **0 dB** or **FLAT**.
- Avoid setting the EQ controls to extreme positions.
- Use natural reproduction as a starting point.
- Rely on your musically trained ear.

INPUT LEVEL control

The **INPUT LEVEL** control adjusts the sensitivity of the incoming signals to the internal operation level of the mixer.

To achieve a good signal input level:

1. Set the volume to **MUTE** using the **MASTER VOLUME** knob.
2. Press the input selection soft key and use the **MASTER VOLUME** knob to set the **INPUT LEVEL** to **MUTE**.
3. Connect the sound source (microphone, instrument, etc) to the selected input.
4. Start the sound source at the highest volume level to be expected. Sing or speak as loudly as possible directly (close up) into the microphone.
5. While playing the sound source or singing into the microphone:
 - Increase the **INPUT LEVEL** by selecting the input channel using the input selection soft key and using the **MASTER VOLUME** knob, so that during the loudest part, the **PK** does not show. Press the input selection soft key again to deselect the input channel.
 - Increase the **MASTER VOLUME** until you get the required output from the loudspeaker.
This is the basic channel setting.

If further adjustments to the EQ setting of the channel are necessary, perform these steps again. Changes in the sound shaping section also have an influence on the overall level of the channel.

48V (INPUT 1 and INPUT 2)

+48V DC phantom power is available on the XLR connector of **INPUT 1** and **INPUT 2**. Phantom power can be used to power certain devices such as DI boxes and condenser microphones (non-electret). Consult the user manual of your device before using. There is no phantom power on the TRS connectors. Phantom power is switchable.



Notice!

Switch off phantom power (default) for sources which do not require phantom power such as dynamic microphones and mixer outputs. With phantom power already activated ensure to mute the input channel when connecting a microphone to avoid loud plop noise.



Notice!

Never connect a mobile device to **INPUT 1** or **INPUT 2** with phantom power activated.

PRESET

The input **PRESET** adjusts the EQ and compressor settings to provide a starting point for adjusting the sound for different input types. Presets are available on **INPUT 1** and **INPUT 2**.

COMP control

The **COMP** control controls the onboard compressor to adjust the input signal processing during operation. Compressors are available on **INPUT 1** and **INPUT 2**.

- ▶ Use the **COMP** control to adjust the compressor threshold and the compression ratio simultaneously.

Adjusting the **COMP** control from 0 to 100 will result in the following:

- The gain below the threshold will increase from 0 dB to +6 dB.
- The compression ratio will increase from 1:1 to 8:1.
- The compressor will reduce the dynamic range of the audio signal proportional to the compressor setting.

Once the signal exceeds a certain threshold, the signal gets compressed. Major input level changes result in minor output level changes. Narrowing the dynamic range often allows for easier recording or mixing of the audio signal. It is recommended to start with low to moderate levels of compression (25 - 40) and increase slowly if necessary.

TREBLE/MID/BASS controls

The EQ section of the input channel allows for a broad difference in the shaping of the incoming audio signal within three frequency bands:

- **TREBLE** control - provides cymbals and vocals with more treble for a more transparent sound.
- **MID** control - increasing this level provides higher output in the vocal range, reducing this level can help reduce acoustical feedback.
- **BASS** control - adds more “punch” to the sound of a kick drum or adds “body” to the vocals.

PAN/BAL

The **PAN** (mono inputs) or **BAL** (stereo inputs) control adjusts the amount of the signal coming out of the stereo L or stereo R loudspeaker in a stereo setup. The **PAN/BAL** is not engaged for mono (single loudspeaker) setups.

DUCKER

The **DUCKER** reduces the level of the signal(s) on all stereo inputs whenever a signal is detected at the selected MIC/LINE input (**INPUT 1** or **INPUT 2**). If no signal is detected at the selected MIC/LINE input, the level of the signal(s) on the stereo inputs will return to the previous set levels.

The **DUCKER** is useful to speak over background music:

- When signal is detected on the selected MIC input, the music on the stereo input channels will be reduced.
- When signal is no longer detected on the selected MIC input, the music will return to the previous level.

Engaging the DUCKER

To engage the ducker:

1. Select **INPUT 1** and/or **INPUT 2**.
2. Adjust the **DUCKER** level to set the detection threshold for the selected input channel. When signal is detected on the selected input, the signal on the stereo inputs will be reduced by 12 dB. Typical values are -10 to -20 dB.

The table below describes the **DUCKER** operation logic. The **DUCKER** setting is the detection threshold selected on **INPUT 1** and/or **INPUT 2**. The ducked channels are the input signals that are reduced by 12 dB.

	INPUT 1	INPUT 2	Reduced channels
DUCKER SETTING	-1 dB - -40 dB	OFF	INPUT 3 to INPUT 8
	OFF	-1 dB - -40 dB	INPUT 3 to INPUT 8
	-1 dB - -40 dB	-1 dB - -40 dB	INPUT 3 to INPUT 8
	OFF	OFF	NONE

8.2 Using AES/EBU digital audio interface

AES/EBU is a professional digital audio interface used for transmitting high-quality, uncompressed digital audio signals from mixing consoles, DJ controllers and other devices.

AES/EBU, or AES3, stands for Audio Engineering Society/European Broadcasting Union, the two entities that jointly developed the standard.

How AES/EBU works

AES/EBU carries two channels of audio over balanced XLR connectors with a wire impedance rating of 110 Ohms. It supports sample rates from 32 kHz to 192 kHz and bit depths up to 24 bits.

Benefits of using AES/EBU

- No conversion of audio signals, preserving the original audio quality
- Compatibility with modern audio standards that rely on digital workflows
- Integration with digital audio networks such as Dante via adaptors or converters
- Ability to use the loudspeaker in live events and installations
- Ability to link multiple loudspeakers in a digital daisy-chain configuration

Setting up the loudspeaker for AES/EBU

To use the AES/EBU feature, you need:

- An AES/EBU output on your mixer or a converter.
Look for the AES/EBU label on your mixer or console.
- A digital XLR cable with a wire impedance rating of 110 Ohms.
The cable should meet the AES/EBU specifications.

To connect the mixer to the loudspeaker:

1. Plug the digital XLR cable to the AES/EBU output on your mixer.
2. Plug the digital XLR cable to the AES/EBU input on your loudspeaker.

9 Recommended configurations

9.1 Stereo pair of EVOLVE70-90 systems

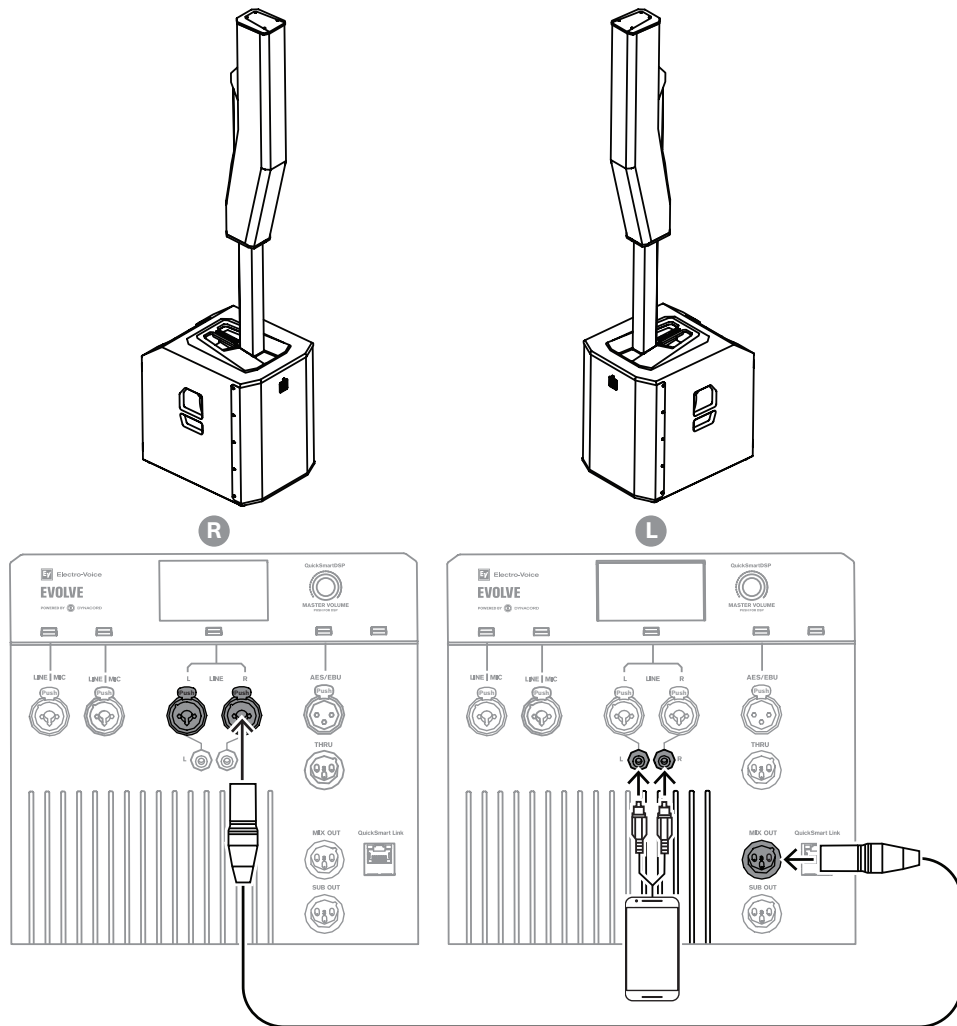

MODE	MUSIC
MASTER SPEAKER (L) MIX OUT	R
SATELLITE SPEAKER (R)	INPUT 3/4 (MONO)

Table 9.1: DSP settings for stereo pair of column loudspeaker systems

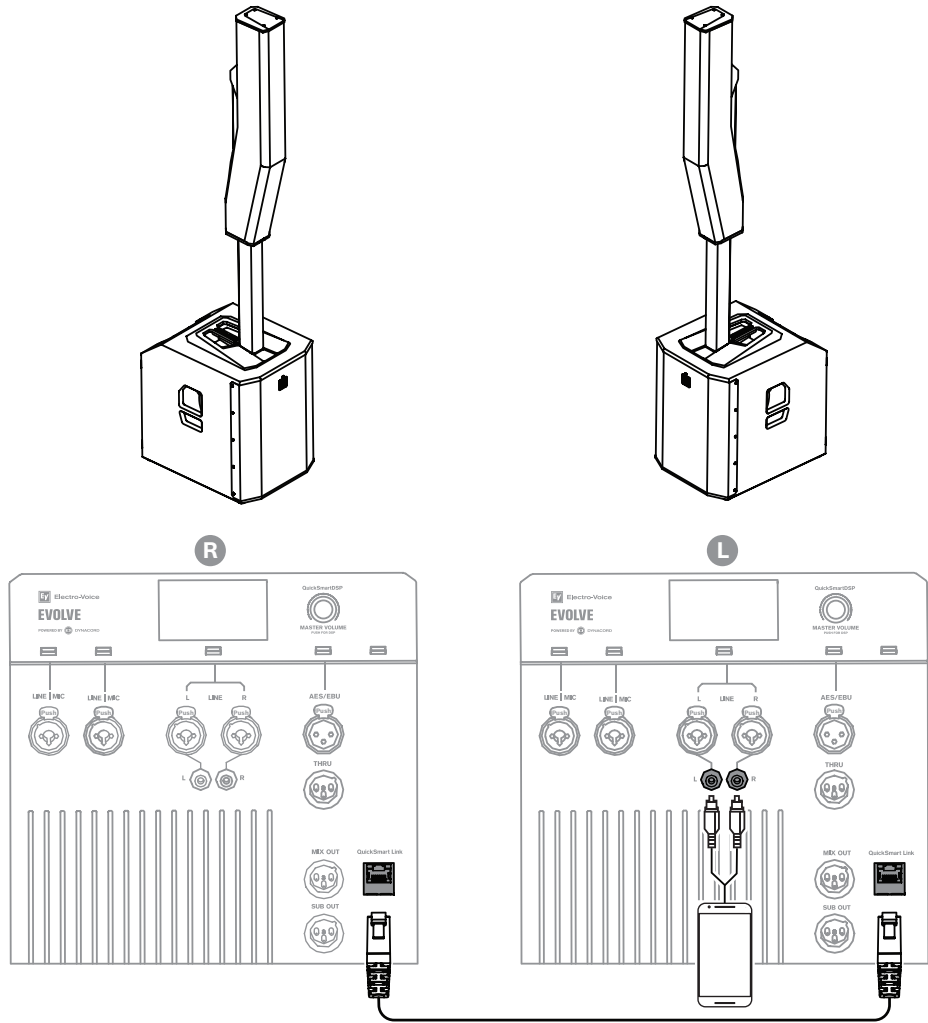

MODE	MUSIC
MASTER SPEAKER (L) SPK OUT	L
SATELLITE SPEAKER (R)	QuickSmart Link input

Table 9.2: DSP settings for the portable column system



Notice!
 Stereo connection from device to the MASTER SPEAKER can be made with hard wires into the stereo INPUT 3/4, via AES/EBU into the stereo INPUT 5/6 AES/EBU or via Bluetooth® into stereo Bluetooth® INPUT 7/8.

9.2 DJ performance

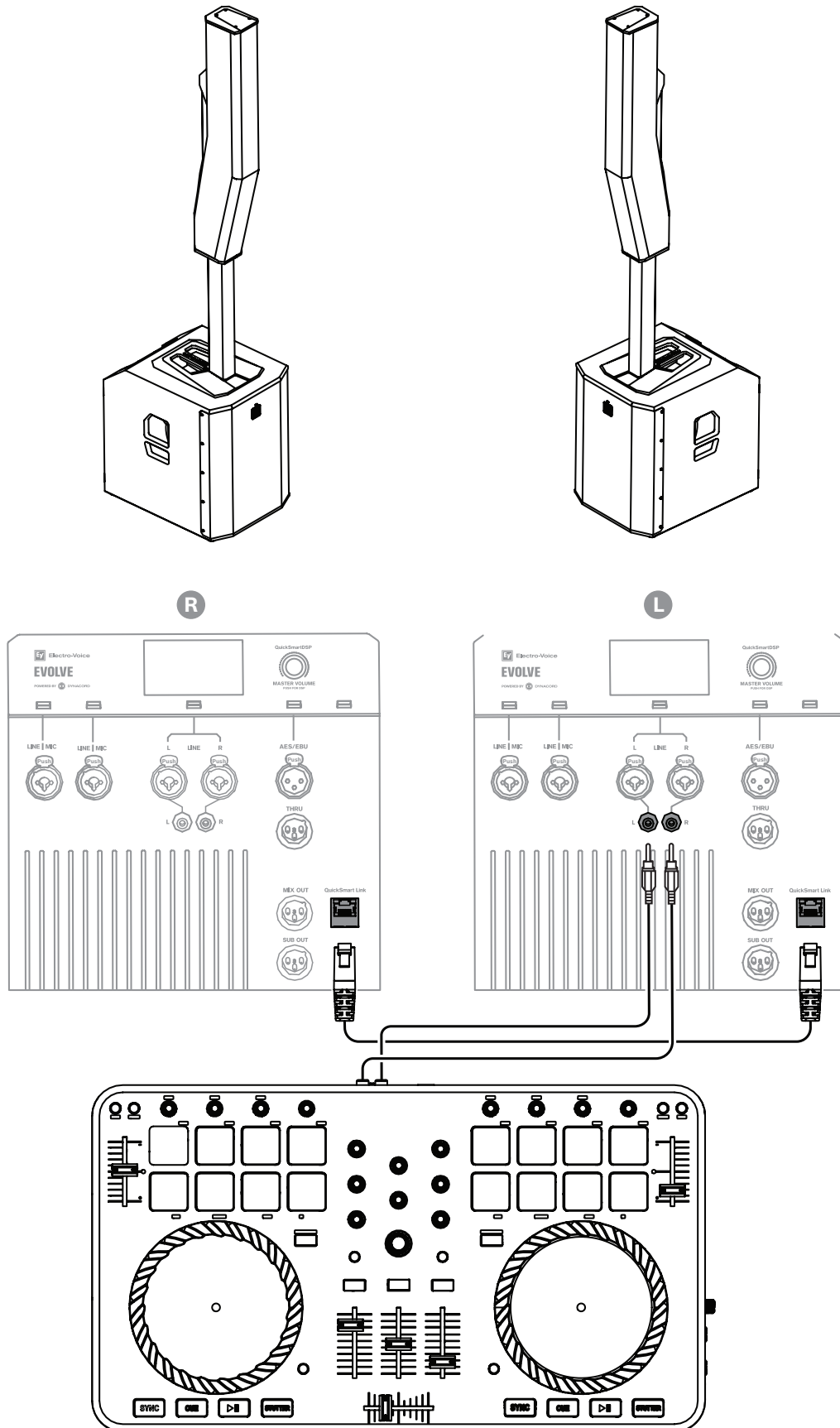

MODE	MUSIC
MASTER SPEAKER (L) SPK OUT	L
SATELLITE SPEAKER (R)	QuickSmart Link input

Table 9.3: DSP settings for DJ performance

9.3 Speaking event

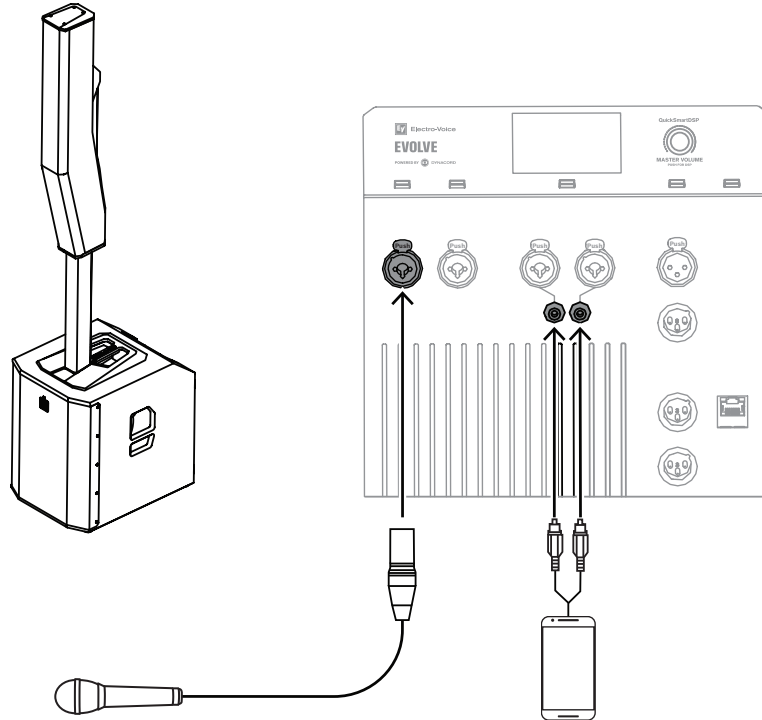

Notice!
The direction of the arrow indicates the signal path.

MODE	SPEECH
------	--------

Table 9.4: DSP settings for speaking event

9.4 Bluetooth true wireless stereo (TWS)

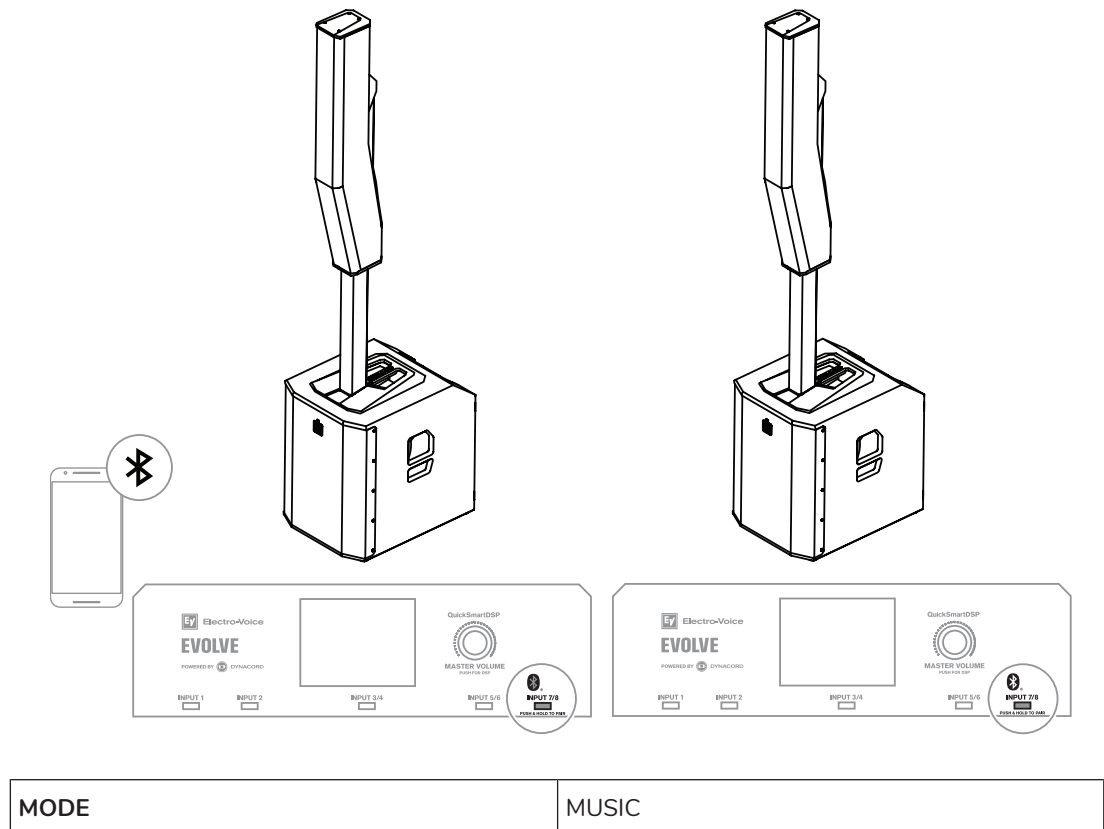
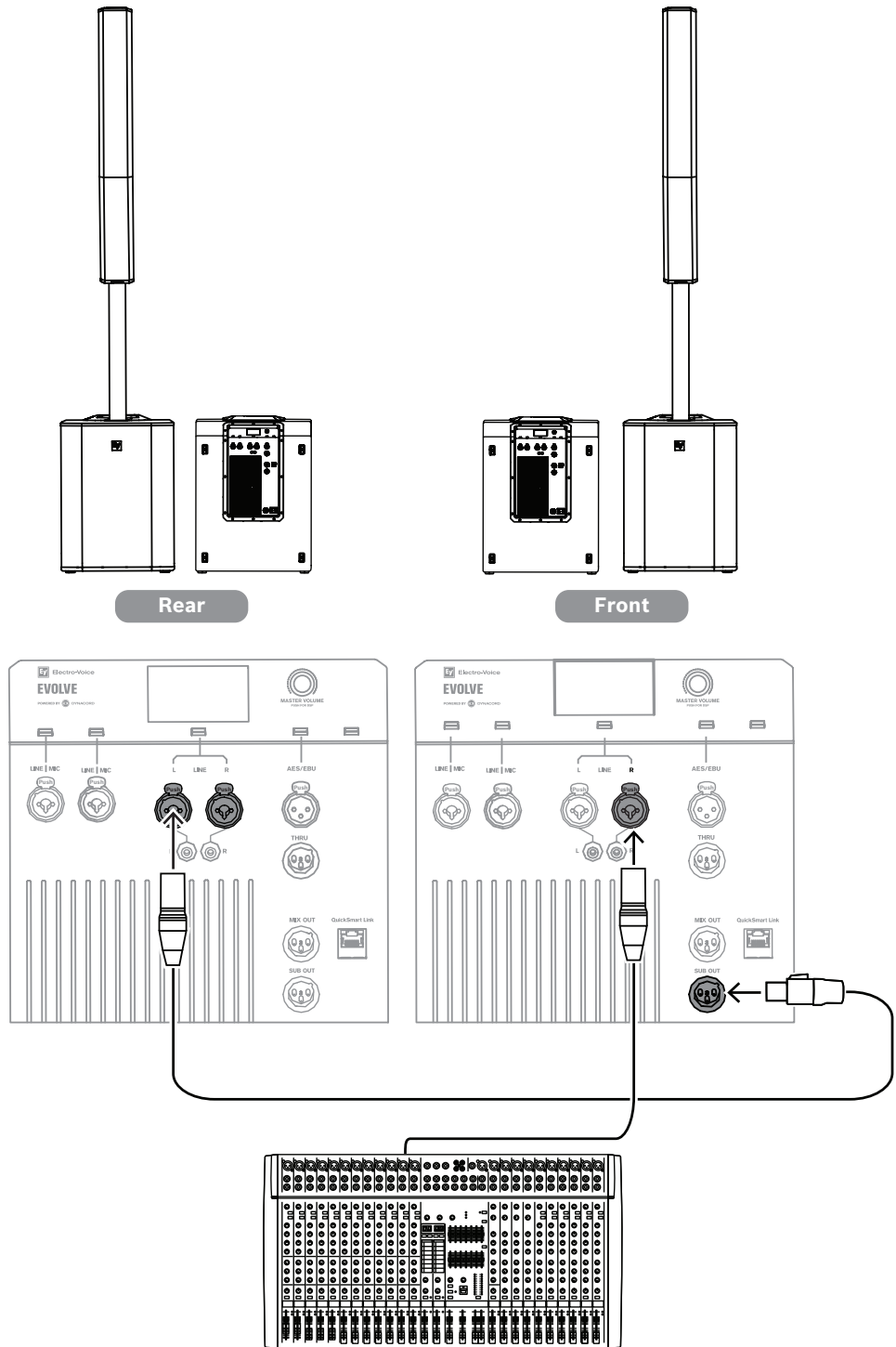

Table 9.5: DSP settings for Bluetooth TWS

To connect two loudspeakers via TWS:

1. Connect one of the loudspeakers to your streaming device via Bluetooth®.
2. Select **LINK SPEAKERS** in the **BLUETOOTH** control menu on both loudspeakers.
3. Change **LINK ROUTE** in the **BLUETOOTH** control menu to select Bluetooth input signal (**L+R**, **L** or **R**).

9.5 Stereo with cardioid subwoofer



SUB CONFIG (Front)	NORMAL
SUB CONFIG (Rear)	CARDIOD

Table 9.6: DSP settings for stereo with cardioid subwoofer

10 Troubleshooting

Problem	Possible cause	Action
1. No sound	Amplifier	Verify all the electronics are on, the signal routing is correct, the source is active; the volume is turned up, no channels are muted, etc. Correct/repair/replace as necessary. If there is still no sound, the problem may be wiring.
	Wiring	Verify you have connected the correct cables to the amplifier. Play something at a low level through the amplifier. Connect a test loudspeaker in parallel with the malfunctioning line. If the sound level is gone or is very weak, the line has a short in it (possibly a severe scrape, pinch, or a missed connection). Using the test loudspeaker, move down the line and test each connection/junction until you find the problem and correct it. Observe proper polarity.
2. Intermittent output such as crackling or distortion	Faulty connection	Check all connections at amplifier and loudspeakers to ensure they are all clean and tight. If the problem persists, check the wiring. See problem 1.
3. Constant noise such as buzzing, hissing or humming	Defective source or other electronic device	If noise is present, but no program material is playing, evaluate each component as necessary to isolate the problem. Most likely there is a break in the signal path.
	Poor system grounding or ground loop	Check and correct the system grounding, as required.
4. No sound produced with microphone connected to line/mic inputs	Microphone requires phantom power.	Ensure the microphone is connected to a line/mic input. Ensure that PHANTOM is set to ON in this channel. Phantom power is not available on line inputs.
	Input channel is muted or LEVEL is too low.	Select the channel and verify the channel is not muted. If it is not muted, slowly increase the channel LEVEL until sound is produced.
5. Sound is distorted, front LED is OFF, LCD screen LIMITER is ON	Excessive input level	Reduce the input level or loudspeaker level to prevent limit.
	Incorrect gain structure or source input (mixing console/preamp) is overdriven	Verify level controls of the source are properly structured by using the VU meter indicator on the LCD screen. If the VU meter bar is solid or the system indicates CLIP or LIMITER , the input or source level is too high.

Problem	Possible cause	Action
6. Microphone produces acoustic feedback when input level is amplified	Incorrect gain structure	Reduce the microphone signal by reducing the INPUT level. Positioning the microphone close to the sound source increases gain before feedback.
	MODE is set to MUSIC	Change the MODE to LIVE or SPEECH.
	Microphone position is too close to the front of the loudspeaker	Whenever possible, setup the loudspeakers so the microphone is behind them. If using a separate loudspeaker in a monitor position, aim the loudspeaker to the back of the microphone.
7. DSP control menu is locked	The menu LOCK function has been turned on. A lock symbol displays on the LCD screen.	Press the MASTER VOLUME knob or input selection soft keys to unlock.
8. QuickSmart Mobile app does not detect the loudspeaker	Enable Bluetooth®	Ensure Bluetooth® is enabled on the loudspeaker. For Android: ensure location services are activated. Remove loudspeaker from iOS/Android in device settings (sometimes called “FORGET”). Restart pairing. Ensure phone/tablet has required OS version and latest updates installed. Ensure the latest QuickSmart Mobile App is installed. Ensure no other phone/tablet is connected to the same loudspeaker.
9. PIN code unlock not successful	Incorrect PIN code entered	Retry PIN code entry Or Press and hold the soft key for INPUT 2 and MASTER VOLUME knob for at least 15 seconds to reset the loudspeaker to default settings.
10. Sound is distorted or interrupted if using QuickSmart Link	Improper cable or cable that is too long	Use shielded CAT5 (or better) cables that are not longer than 100 m (328 ft).
	Network hardware (Switches / Routers) connected	Only a direct connection between no more than two EVOLVE systems is allowed to work correctly.

If these suggestions do not solve your problem, contact your nearest Electro-Voice dealer or Electro-Voice distributor.

11 Technical data

	EVOLVE 70	EVOLVE 90
Column	(8) 4.7-inch neodymium drivers	
Subwoofer	(1) 15-inch woofer with 3-inch voice coil	(1) 18-inch cast frame woofer with 4-inch voice coil
Frequency response (-3 dB) (Hz) ¹	40 Hz - 18000 Hz	35 Hz - 18000 Hz
Frequency range (-10 dB) (Hz) ¹	35 Hz - 20000 Hz	28 Hz - 20000 Hz
Maximum sound pressure level at a distance of 1 m (dB) ²	133 dB	134 dB
Coverage angle H x V (°)	120° x 25°	
Amplifier rating (W)	2000 W	
Power consumption (V, Hz, A) ³	100 - 240 VAC, 50 - 60 Hz, 2.1 ~ 0.9 A	
LF channel rating (W)	1000 W	
HF channel rating (W)	1000 W	
Crossover frequency (Hz)	160 Hz	
Connector type	powerCON® power input Dual XLR/TRS combo jack mic / line inputs with switchable 48V phantom power Stereo XLR/TRS combo jack line input Stereo RCA line input XLR AES/EBU input XLR AES/EBU thru XLR Mix out XLR Sub out RJ45 QuickSmart Link connector Bluetooth Stereo input with TWS	
Material	Plywood with polyurea coating (subwoofer) Composite (column) Aluminum (pole)	
Grille material	Steel with black or white powder coat	
Color	Black or white	
Dimensions (H x W x D) (in)	24.5 in x 17.7 in x 23.9 in (subwoofer) 42.9 in x 5.2 in x 10.2 in (column) 29.3 in x 2.6 in x 3.8 in (pole)	27.3 in x 20.1 in x 26.8 in (subwoofer) 42.9 in x 5.2 in x 10.2 in (column) 29.3 in x 2.6 in x 3.8 in (pole)
Dimensions (H x W x D) (mm)	623 mm x 450 mm x 607 mm (subwoofer) 1090.1 mm x 131.4 mm x 259	694 mm x 510 mm x 680mm (subwoofer) 1090.1 mm x 131.4 mm x 259

	EVOLVE 70	EVOLVE 90
	mm (column) 745 mm x 66 mm x 95.8 mm (pole)	mm (column) 745 mm x 66mm x 95.8mm (pole)
Assembled dimensions (H x W x D) (in)	88.9 in x 17.7 in x 23.9 in	92.4 in x 20.1 in x 26.8 in
Assembled dimensions (H x W x D) (mm)	2259 mm x 450 mm x 607 mm	2346 mm x 510 mm x 680 mm
Shipping dimensions (H x W x D) (in)	27.3 in x 20.4 in x 26.7 in (subwoofer) 45.2 in x 7.6 in x 14.4 in (column and pole)	29.8 in x 22.6 in x 29.2 in (subwoofer) 45.2 in x 7.6 in x 14.4 in (column and pole)
Shipping dimensions (H x W x D) (mm)	693 mm x 520 mm x 677 mm (subwoofer) 1150 mm x 193 mm x 365 mm (column and pole)	758 mm x 575 mm x 741 mm (subwoofer) 1150 mm x 193 mm x 365 mm (column and pole)
Weight (lb)	78.3 lbs	98.1 lbs
Weight (kg)	35.5 kg	44.5 kg
Shipping weight (lb)	72.8 lb (subwoofer) 25.1 lb (column and pole)	94.8 lb (subwoofer) 25.1 lb (column and pole)
Shipping weight (kg)	33 kg (subwoofer) 11.4 kg (column and pole)	43 kg (subwoofer) 11.4 kg (column and pole)

¹Full-space measurement using **MUSIC** DSP preset.

²Maximum SPL is measured at 1 m using broadband pink noise at maximum output.

³Current rating is 1/8 power.

Frequency response¹

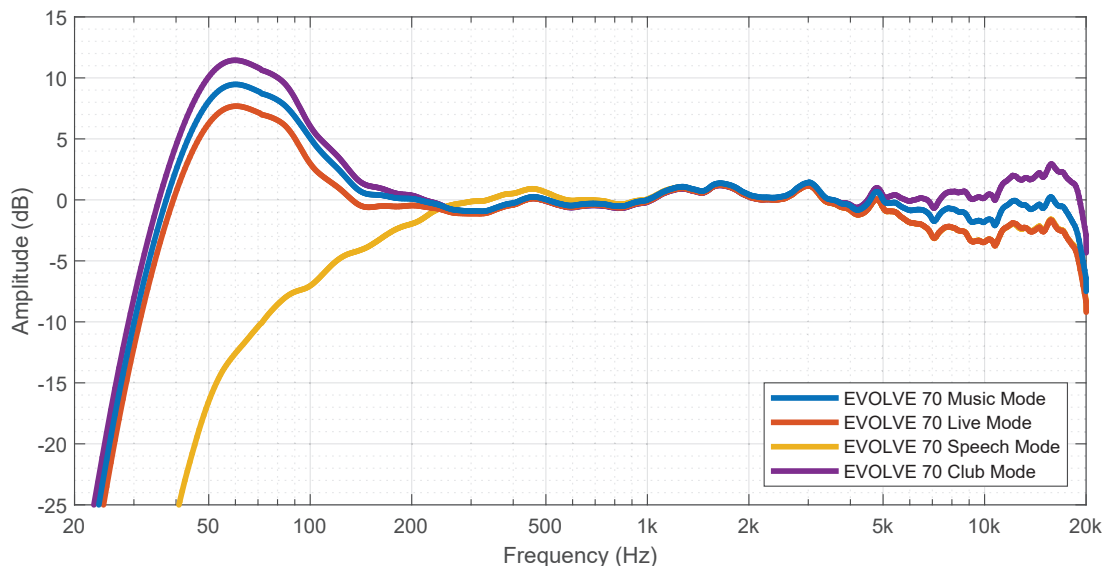

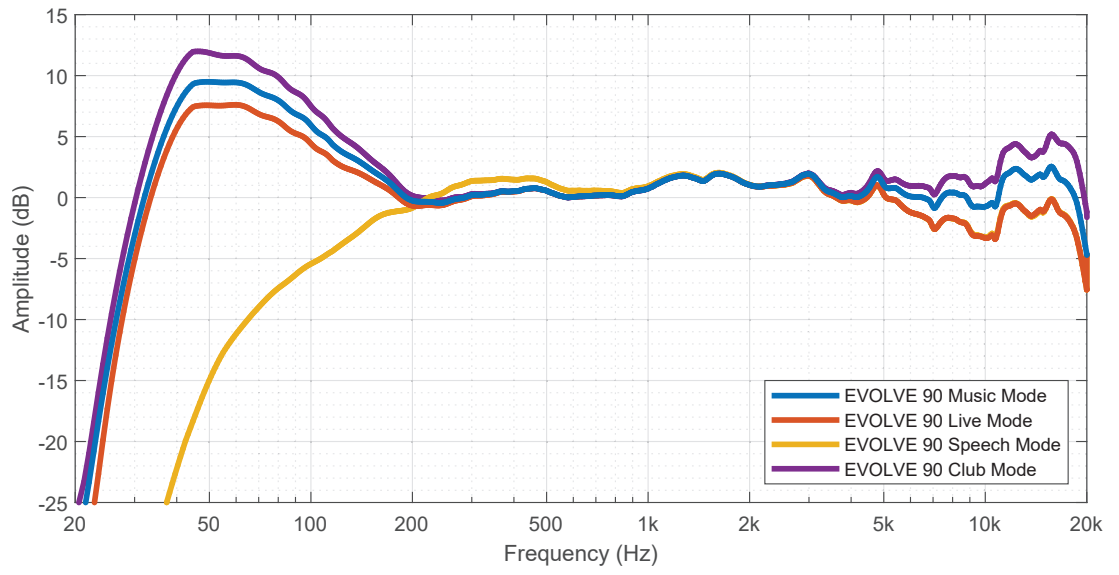

¹ On-axis full-space measurement

11.1 Block diagram

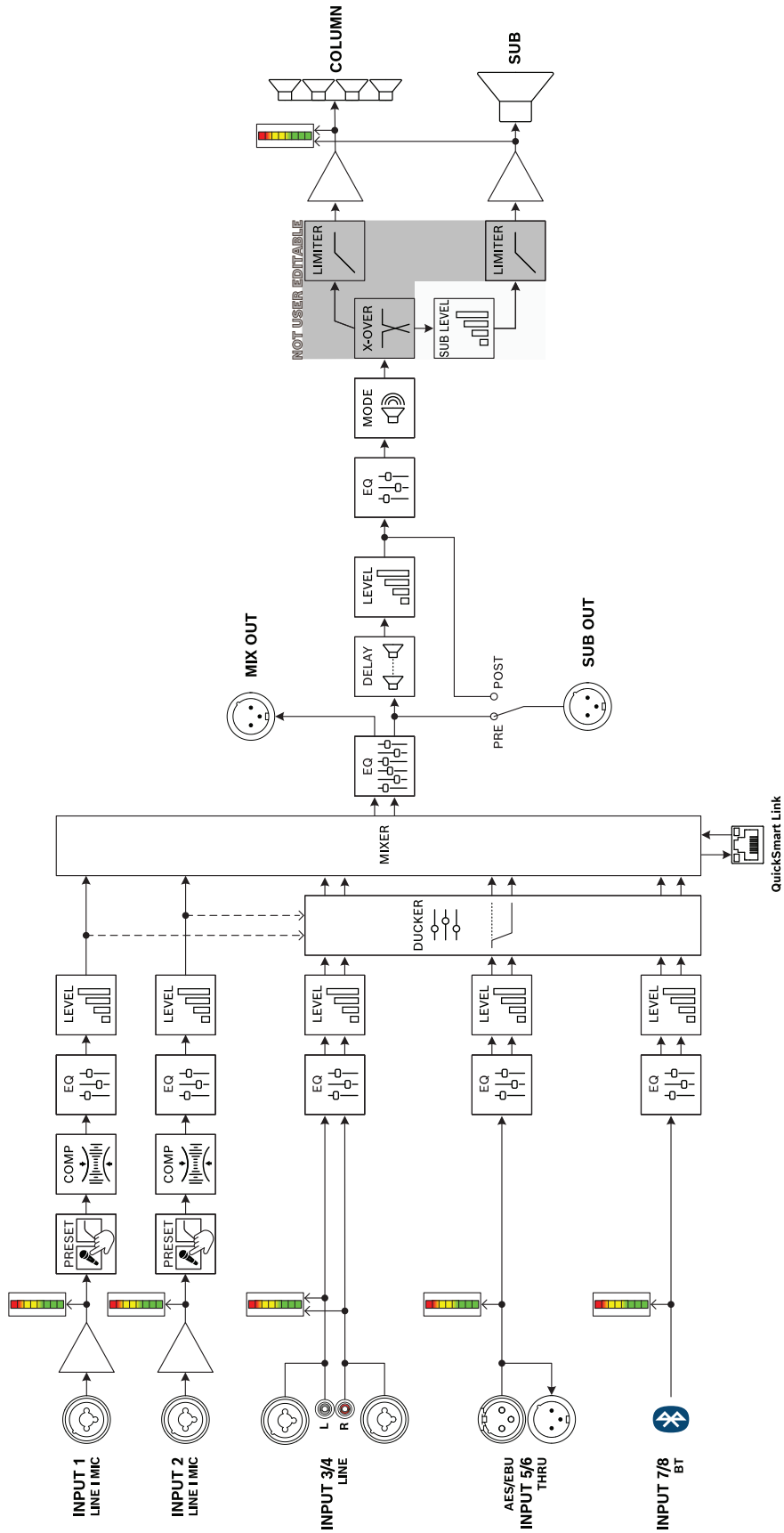

11.2 Dimensions

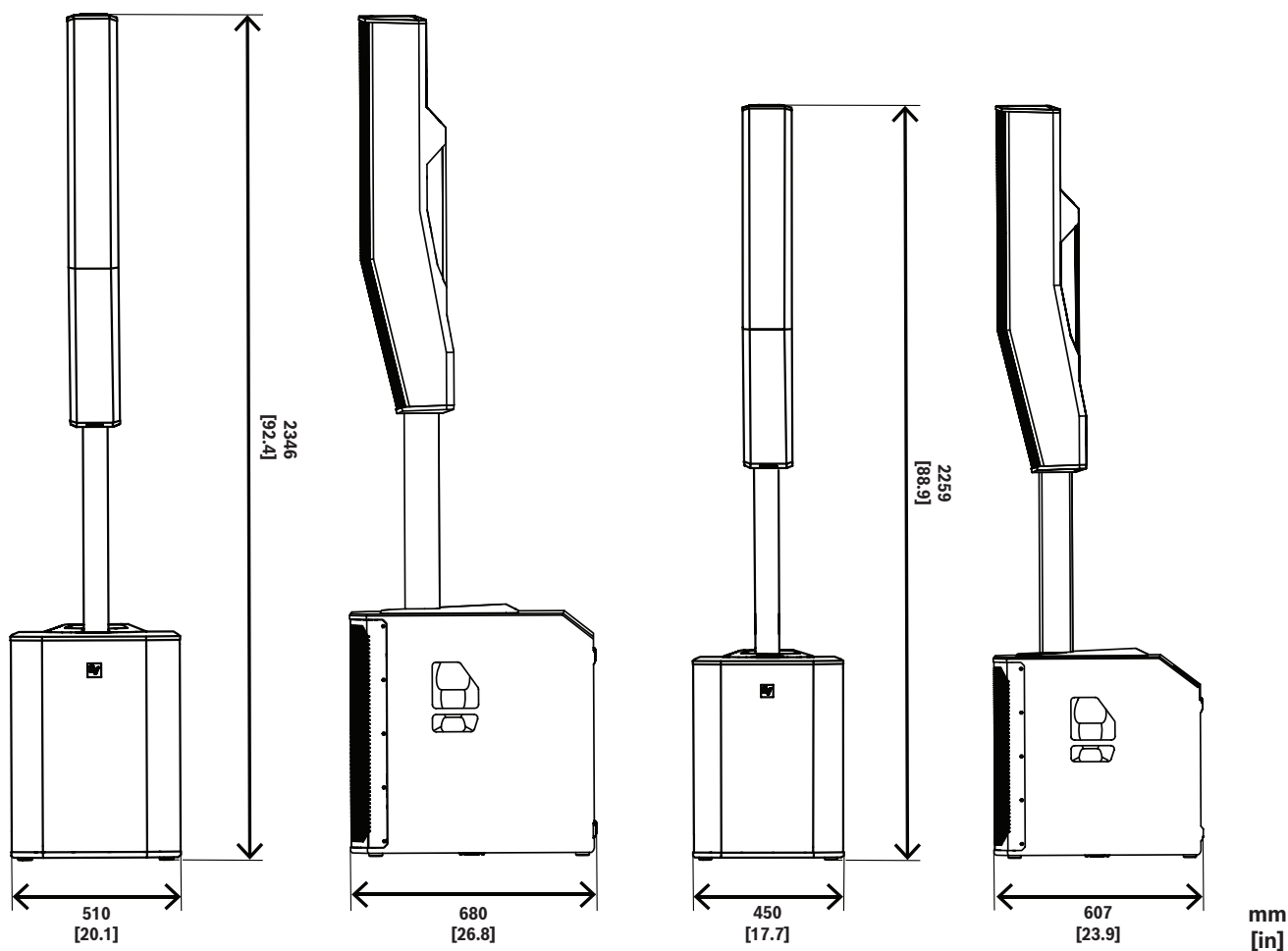
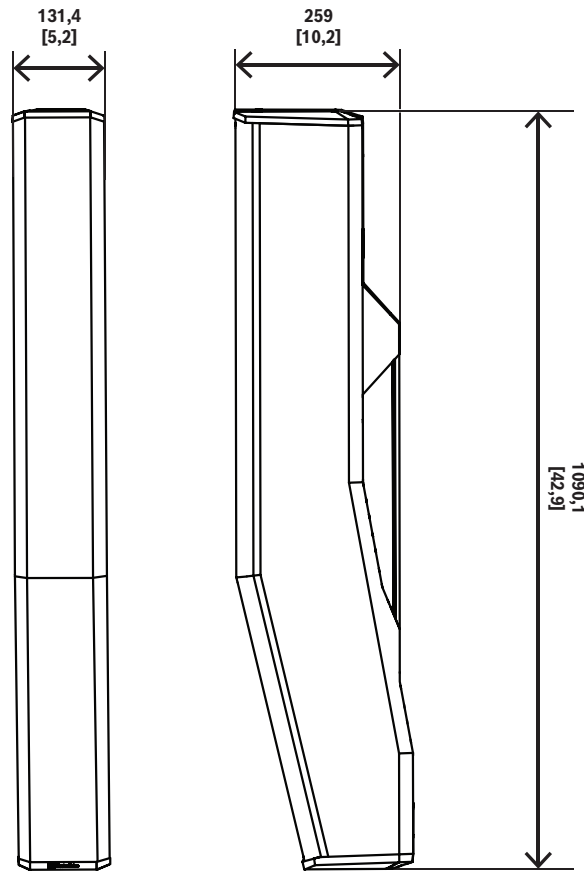
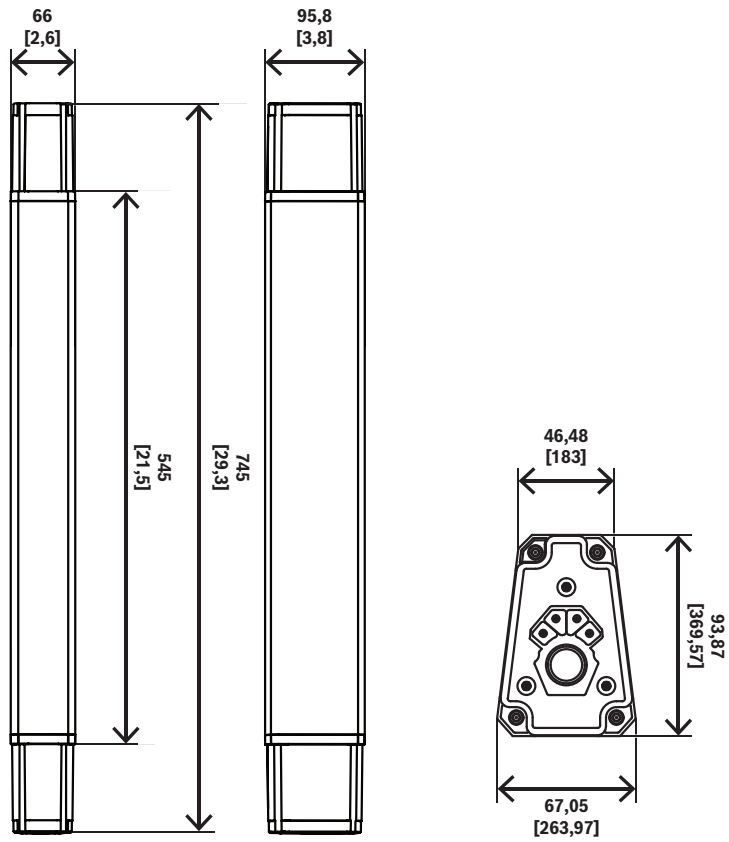

Figure 11.1: EVOLVE 90 and EVOLVE 70 systems



mm
[in]

Figure 11.2: EVOLVE70-90 column



mm
[in]

Figure 11.3: EVOLVE70-90 pole

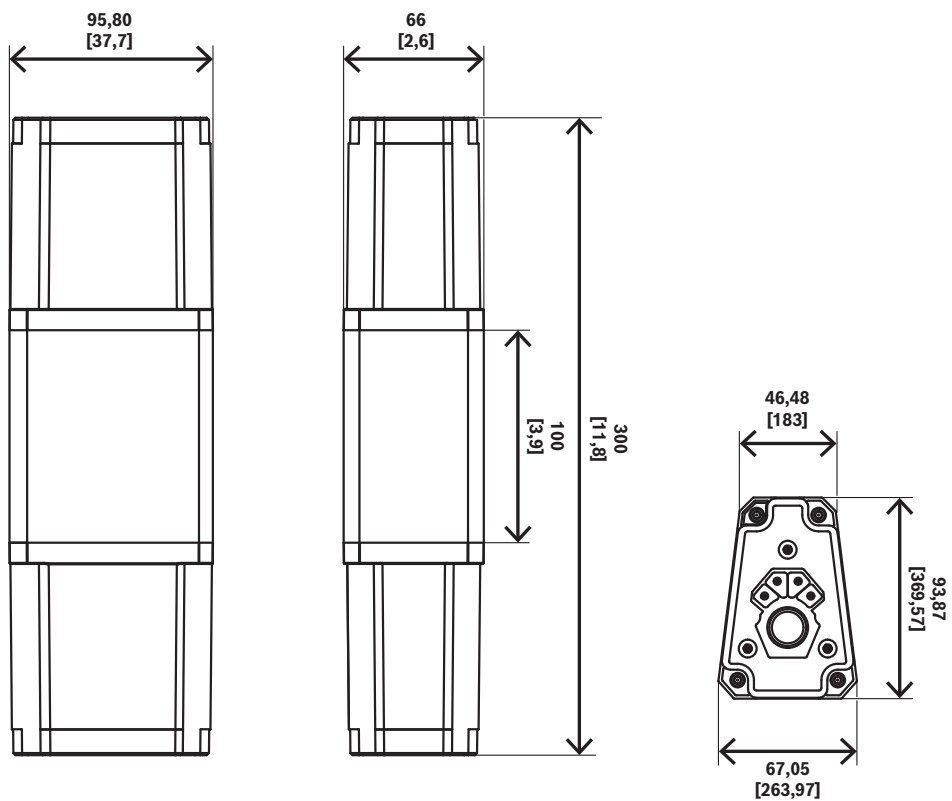

mm
[in]

Figure 11.4: EVOLVE70-90 short pole, sold separately

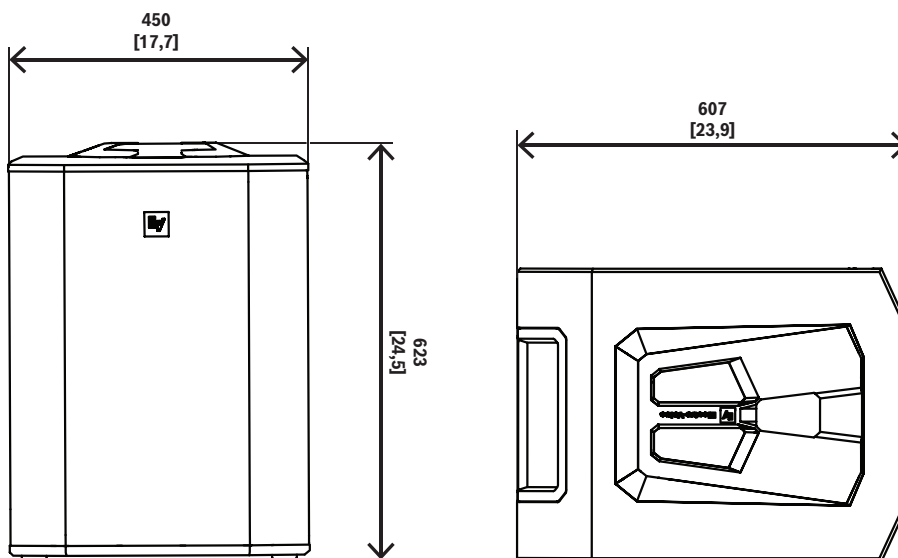

mm
[in]

Figure 11.5: EVOLVE 70 subwoofer

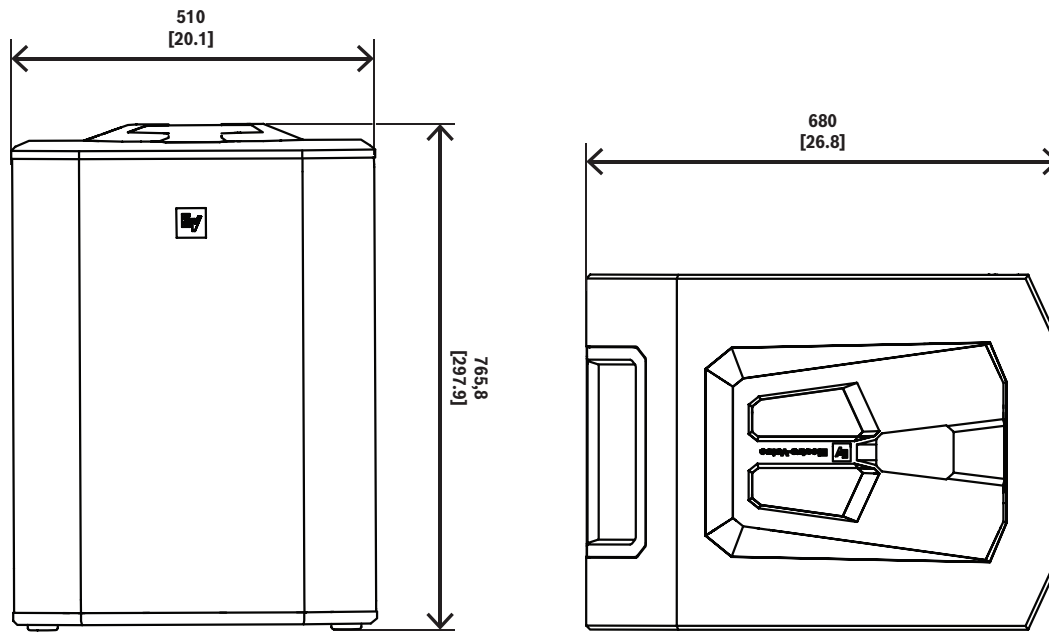

mm
[in]

Figure 11.6: EVOLVE 90 subwoofer

12

Appendices

12.1

Effects (FX) list

Note: Subject to change without notice

Number	Name App	Name LCD
0	OFF	OFF
1	Echo+ReverbShort	ECHO+REVERB S
2	Reverb Room	REV ROOM
3	Reverb Concert Hall	REV CONCERT
4	Reverb Large Hall	REV HALL
5	Reverb Church	REV CHURCH
6	Reverb Room Soft	REV ROOM S
7	Reverb Concert Hall Soft	REV CONCERT S
8	Reverb Large Hall Soft	REV HALL S
9	Reverb Church Soft	REV CHURCH S
10	Reverb Cathedral Soft	REV CATHEDRAL S
11	Reverb Plate Medium	PLATE MEDIUM
12	Reverb Plate Long	PLATE LONG
13	Reverb Plate Medium Soft	PLATE MEDIUM S
14	Reverb Plate Long Soft	PLATE LONG S
15	Reverb+ChorusSlow	REV+CHORUS SLOW
16	Reverb+ChorusMedium	REV+CHORUS MEDIUM
17	Reverb+ChorusFast	REV+CHORUS FAST
18	Delay Short	DELAY SHORT
19	Delay Long	DELAY LONG
20	Delay Tap	DELAY TAP
21	Chorus Slow	CHORUS SLOW
22	Chorus Medium	CHORUS MEDIUM
23	Chorus Fast	CHORUS FAST
24	Chorus+Echo Slow	CHORUS+ECHO S
25	Chorus+EchoMedium	CHORUS+ECHO M
26	Chorus+Echo Fast	CHORUS+ECHO F
27	Slap Back+EchoSlow	SLAPBACK+ECHO S
28	Slap Back+EchoFast	SLAPBACK+ECHO F
29	Doubling Narrow	DOUBLING NARROW
30	Doubling Wide	DOUBLING WIDE

12.2 Warranty information

For information on warranty periods and after sales service, please visit: www.electrovoice.com/warranty

12.3 OUTPUT list

VOLUME	0 dB (Default)		
	MUTE, -80 dB- +10 dB, (1 dB)		
	EXIT		
	MODE	MUSIC (Default)	
		LIVE	
		SPEECH	
		CLUB	
	SUB LEVEL	0 dB (Default)	
		MUTE	
		-80 dB - +10 dB (1 dB)	
	TREBLE	0 dB (Default)	
		-12 dB - +6 dB	
	MID	0 dB (Default)	
		-12 dB - +6 dB	
	BASS	0 dB (Default)	
		-12 dB - +6 dB	
	MAIN EQ (PEQ selected)	BACK	
		ENABLE ALL	ON (Default)
			OFF
		RESET ALL	NO (Default)
			YES
		PEQ #	1 (Default)
			1 - 7
BYPASS		OFF (Default)	
		ON	
TYPE		PEQ (Default)	
		LOW SHELF	
		HIGH SHELF	

			LOW PASS
			HIGH PASS
	Q (PEQ only)	0.7 (Default)	
		0.5 - 10.0	
	FREQ	63 Hz (Default)	
		20 Hz - 20 kHz	
	GAIN (PEQ, LOW SHELF and HI SHELF only)	0 dB (Default)	
		-12 dB - +12 dB	
	RESET	NO (Default)	
		YES	
	BACK		
	MAIN EQ (GEQ selected)	BACK	
	63 Hz	0 dB (Default)	
	160 Hz	-12 dB - +12 dB (1 dB)	
	400 Hz		
	1 kHz		
	2.5 kHz		
	6 kHz		
	12 kHz		
	RESET	RESET ALL BANDS? YES/NO	
	BACK		
	FX	01 (Default)	
		00 - 30	
	FX Delay (FX 20 only)	427 ms (Default)	
		30 ms - 550 ms	
	FX ENABLE	ON (Default)	
		OFF	
	DELAY	BACK	
	DELAY	OFF (Default)	
		0.1 m - 100.0 m	
	SUB DELAY	OFF (Default)	
		-10.0 m - +10.0 m	

	UNIT	METER FEET MILLISECONDS	
	BACK		
SPK OUT	L + R (Default)		
	L		
	R		
MIX OUT	L + R (Default)		
	L		
	R		
SUB CONFIG	NORMAL (Default)		
	CARDIOID		
BLUETOOTH	BACK		
	BLUETOOTH	ON (Default)	
		OFF	
	ID (4-digit unique device number)		
	CONTROL PAIR		
	AUDIO PAIR		
	LINK SPEAKERS		
	LINK ROUTE	L+R (Default)	
		L	
		R	
	AUTO RECONNECT	OFF (Default)	
		ON	
	BACK		
LED	ON (Default)		
	OFF		
	LIMITER		
DISPLAY	BACK		
	PIN LOCK	OFF (Default)	
		TUNE	
		ALL	
	LOCK NOW (only if PIN is set)		
	DIM	30 s (Default)	
		10 s - 60 s	

		OFF
	BRIGHT	5 (Default)
		1 - 10
	BACK	
	STORE	BACK, 1, 2, 3, 4, 5, BACK
	RECALL	BACK, 1, 2, 3, 4, 5, 6 (Default), BACK
	RESET	DEFAULT SETTINGS?
		NO (Default)
		YES
		ERASE USER PRESETS?
		NO (Default)
		YES
	IMPRINT & LICENSE	[OSS license text]
	INFO	[FIRMWARE VERSION]
		©2025 Electro-Voice
	EXIT	

Table 12.1: Loudspeaker DSP control menu

12.4

INPUT list

INPUT DSP control menu

INPUTS 1 & 2		
LEVEL		0 dB (Default)
		MUTE, -80 dB - +42 dB
	EXIT	
	PHANTOM	OFF (Default)
		ON
	PRESET	FLAT (Default)
		LOW CUT 80
		LOW CUT 120
		VOCAL MIC
		VOICE FILTER
		ND76 VOCAL
		RE520
		ND86 VOCAL

		ND96 VOCAL
		SPEECH
		LINE INPUT
	COMP	OFF (Default)
		OFF, 1 - 100
	TREBLE	0 dB (Default)
		-12 dB - +12 dB
	MID	0 dB (Default)
		-12 dB - +12 dB
	BASS	0 dB (Default)
		-12 dB - +12 dB
	PAN (stereo operation only)	C (Default)
		10 L - 10 R
	DUCKER	OFF (Default)
		OFF, -1 - -40
	EXIT	

Table 12.2: INPUTS 1 & 2 DSP control menu

INPUT 3/4 & INPUT 5/6		
LEVEL		0 dB (Default)
		MUTE, -80 dB - +10 dB
	EXIT	
	TREBLE	0 dB (Default)
		-12 dB - +12 dB
	MID	0 dB (Default)
		-12 dB - +12 dB
	BASS	0 dB (Default)
		-12 dB - +12 dB
	BAL (stereo operation only)	C (Default)
		10 L - 10 R
	EXIT	

Table 12.3: INPUT 3/4 & 5/6 DSP control menu

INPUT 7/8			
LEVEL	0 dB (Default)		
	MUTE, -80 dB - +10 dB		
	EXIT		
	TREBLE	0 dB (Default)	
		-12 dB - +12 dB	
	MID	0 dB (Default)	
		-12 dB - +12 dB	
	BASS	0 dB (Default)	
		-12 dB - +12 dB	
	BAL (stereo operation only)	C (Default)	
		10 L - 10 R	
	BLUETOOTH	BACK	
		BLUETOOTH	ON (Default)
			OFF
		ID (4-digit unique device number)	
		CONTROL PAIR	
		AUDIO PAIR	
LINK SPEAKERS			
LINK ROUTE		L+R (Default)	
		L	
		R	
AUTO RECONNECT		OFF (Default)	
		ON	
BACK			
EXIT			

Table 12.4: INPUT 7/8 DSP control menu

12.5 Regulatory information

12.5.1 FCC information

IMPORTANT: Do not modify this unit! Changes or modifications not expressly approved by the manufacturer could void the user’s authority, granted by the FCC, to operate the equipment.

**Notice!**

This equipment has been tested and found to comply with the limits for a Class B digital device, pursuant to Part 15 of the FCC Rules. These limits are designed to provide reasonable protection against harmful interference in a residential installation. This equipment generates, uses and can radiate radio frequency energy and, if not installed and used in accordance with the instructions, may cause harmful interference to radio communications. However, there is no guarantee interference will not occur in a particular installation.

If this equipment does cause harmful interference to radio or television reception or receive audible interference from radio, television or communications equipment, which can be determined by turning the equipment off and on. The user is encouraged to try to correct the interference by one or more of the following measures:

- Reorient or relocate the receiving antenna.
- Increase the separation between the equipment and receiver.
- Connect the equipment into an outlet on a circuit different from that to which the receiver is connected.
- Consult the dealer or an experienced radio/TV/communications equipment technician.

The device has been granted by FCC and IC the FCC ID ESVEVOLVE2 and IC ID 1249A-EVOLVE2.

Please take attention that changes or modification not expressly approved by the party responsible for compliance could void the user's authority to operate the equipment.

This equipment should be installed and operated with a minimum distance of 20 cm between the radiator and your body.

This equipment complies with FCC/IC RSS-102 radiation exposure limits set forth for an uncontrolled environment.

This device complies with Part 15 of the FCC Rules and Industry Canada license-exempt RSS standard(s). Operation is subject to the following two conditions:

- (1) this device may not cause interference, and
- (2) this device must accept any interference, including interference that may cause undesired operation of the device.

Le présent appareil est conforme aux CNR d'Industrie Canada applicables aux appareils radioexempts de licence. L'exploitation est autorisée aux deux conditions suivantes :

- (1) l'appareil ne doit pas produire de brouillage, et
- (2) l'utilisateur de l'appareil doit accepter tout brouillage radioélectrique subi, même si le brouillage est susceptible d'en compromettre le fonctionnement.

12.5.2**Simplified Declaration of Conformity (sDoC) for Europe (CE)**

BG	С настоящото Bosch Security Systems, LLC декларира, че този тип радиосъоръжение EVOLVE70-SB-EU, EVOLVE90-SB-EU, EVOLVE70-SW, EVOLVE90-SW е в съответствие с Директива 2014/53/ЕС. Цялостният текст на ЕС декларацията за съответствие може да се намери на следния интернет адрес: www.electrovoice.com
CS	Tímto Bosch Security Systems, LLC prohlašuje, že typ rádiového zařízení EVOLVE70-SB-EU, EVOLVE90-SB-EU, EVOLVE70-SW, EVOLVE90-SW je v souladu se směrnicí 2014/53/EU. Úplné znění EU prohlášení o shodě je k dispozici na této internetové adrese: www.electrovoice.com

DA	Hermed erklærer Bosch Security Systems, LLC , at radioudstyrstypen EVOLVE70-SB-EU, EVOLVE90-SB-EU, EVOLVE70-SW, EVOLVE90-SW er i overensstemmelse med direktiv 2014/53/EU. EU-overensstemmelseserklæringens fulde tekst kan findes på følgende internetadresse: www.electrovoice.com
DE	Hiermit erklährt Bosch Security Systems, LLC , dass der Funkanlagentyp EVOLVE70-SB-EU, EVOLVE90-SB-EU, EVOLVE70-SW, EVOLVE90-SW der Richtlinie 2014/53/EU entspricht. Der vollständige Text der EU-Konformitätserklärung ist unter der folgenden Internetadresse verfügbar: www.electrovoice.com
EL	Με την παρούσα ο/η Bosch Security Systems, LLC , δηλώνει ότι ο ραδιοεξοπλισμός EVOLVE70-SB-EU, EVOLVE90-SB-EU, EVOLVE70-SW, EVOLVE90-SW πληροί την οδηγία 2014/53/ΕΕ. Το πλήρες κείμενο της δήλωσης συμμόρφωσης ΕΕ διατίθεται στην ακόλουθη ιστοσελίδα στο διαδίκτυο: www.electrovoice.com
EN	Hereby, Bosch Security Systems, LLC declares that the radio equipment type EVOLVE70-SB-EU, EVOLVE90-SB-EU, EVOLVE70-SW, EVOLVE90-SW is in compliance with Directive 2014/53/EU and the relevant statutory requirements. The full text of the EU declaration of conformity is available at the following internet address: www.electrovoice.com .
ES	Por la presente, Bosch Security Systems, LLC declara que el tipo de equipo radioeléctrico EVOLVE70-SB-EU, EVOLVE90-SB-EU, EVOLVE70-SW, EVOLVE90-SW es conforme con la Directiva 2014/53/UE. El texto completo de la declaración UE de conformidad está disponible en la dirección Internet siguiente: www.electrovoice.com .
ET	Käesolevaga deklareerib Bosch Security Systems, LLC , et käesolev raadioseadme tüüp EVOLVE70-SB-EU, EVOLVE90-SB-EU, EVOLVE70-SW, EVOLVE90-SW vastab direktiivi 2014/53/EL nõuetele. Eli vastavusdeklaratsiooni täielik tekst on kättesaadav järgmisel internetiaadressil: www.electrovoice.com
FI	Bosch Security Systems, LLC vakuuttaa, että radiolaitetyyppi EVOLVE70-SB-EU, EVOLVE90-SB-EU, EVOLVE70-SW, EVOLVE90-SW on direktiivin 2014/53/EU mukainen. EU-vaatimustenmukaisuusvakuutuksen täysimittainen teksti on saatavilla seuraavassa internetosoitteessa: www.electrovoice.com
FR	Le soussigné, Bosch Security Systems, LLC , déclare que l'équipement radioélectrique du type EVOLVE70-SB-EU, EVOLVE90-SB-EU, EVOLVE70-SW, EVOLVE90-SW est conforme à la directive 2014/53/UE. Le texte complet de la déclaration UE de conformité est disponible à l'adresse internet suivante: www.electrovoice.com
HR	Bosch Security Systems, LLC ovime izjavljuje da je radijska oprema tipa EVOLVE70-SB-EU, EVOLVE90-SB-EU, EVOLVE70-SW, EVOLVE90-SW u skladu s Direktivom 2014/53/EU. Cjeloviti tekst EU izjave o sukladnosti dostupan je na sljedećoj internetskoj adresi: www.electrovoice.com
HU	Bosch Security Systems, LLC igazolja, hogy a EVOLVE70-SB-EU, EVOLVE90-SB-EU, EVOLVE70-SW, EVOLVE90-SW típusú rádióberendezés megfelel a 2014/53/EU irányelvnek. Az EU-megfelelőségi nyilatkozat teljes szövege elérhető a következő internetes címen: www.electrovoice.com
IT	Il fabbricante, Bosch Security Systems, LLC , dichiara che il tipo di apparecchiatura radio EVOLVE70-SB-EU, EVOLVE90-SB-EU, EVOLVE70-SW, EVOLVE90-SW è conforme alla direttiva 2014/53/UE. Il testo completo della dichiarazione di conformità UE è disponibile al seguente indirizzo Internet: www.electrovoice.com

LT	Aš, Bosch Security Systems, LLC , patvirtinu, kad radijo įrenginių tipas EVOLVE70-SB-EU, EVOLVE90-SB-EU, EVOLVE70-SW, EVOLVE90-SW atitinka Direktyvą 2014/53/ES. Visas ES atitikties deklaracijos tekstas prieinamas šiuo interneto adresu: www.electrovoice.com
LV	Ar šo Bosch Security Systems, LLC deklarē, ka radioiekārta EVOLVE70-SB-EU, EVOLVE90-SB-EU, EVOLVE70-SW, EVOLVE90-SW atbilst Direktīvai 2014/53/ES. Pilns ES atbilstības deklarācijas teksts ir pieejams šādā interneta vietnē: www.electrovoice.com
MT	B'dan, Bosch Security Systems, LLC , niddikjara li dan it-tip ta' tagħmir tar-radju EVOLVE70-SB-EU, EVOLVE90-SB-EU, EVOLVE70-SW, EVOLVE90-SW huwa konformi mad-Direttiva 2014/53/UE. It-test kollu tad-dikjarazzjoni ta' konformità tal-UE huwa disponibbli f'dan l-indirizz tal-Internet li ġej: www.electrovoice.com
NL	Hierbij verklaar ik, Bosch Security Systems, LLC , dat het type radioapparatuur EVOLVE70-SB-EU, EVOLVE90-SB-EU, EVOLVE70-SW, EVOLVE90-SW conform is met Richtlijn 2014/53/EU. De volledige tekst van de EU-conformiteitsverklaring kan worden geraadpleegd op het volgende internetadres: www.electrovoice.com
PL	Bosch Security Systems, LLC niniejszym oświadcza, że typ urządzenia radiowego EVOLVE70-SB-EU, EVOLVE90-SB-EU, EVOLVE70-SW, EVOLVE90-SW jest zgodny z dyrektywą 2014/53/UE. Pełny tekst deklaracji zgodności UE jest dostępny pod następującym adresem internetowym: www.electrovoice.com
PT	O(a) abaixo assinado(a) Bosch Security Systems, LLC declara que o presente tipo de equipamento de rádio EVOLVE70-SB-EU, EVOLVE90-SB-EU, EVOLVE70-SW, EVOLVE90-SW está em conformidade com a Diretiva 2014/53/UE. O texto integral da declaração de conformidade está disponível no seguinte endereço de Internet: www.electrovoice.com
RO	Prin prezenta, Bosch Security Systems, LLC declară că tipul de echipamente radio EVOLVE70-SB-EU, EVOLVE90-SB-EU, EVOLVE70-SW, EVOLVE90-SW este în conformitate cu Directiva 2014/53/UE. Textul integral al declarației UE de conformitate este disponibil la următoarea adresă internet: www.electrovoice.com
SK	Bosch Security Systems, LLC týmto vyhlasuje, že rádiové zariadenie typu EVOLVE70-SB-EU, EVOLVE90-SB-EU, EVOLVE70-SW, EVOLVE90-SW je v súlade so smernicou 2014/53/EÚ. Úplné EÚ vyhlásenie o zhode je k dispozícii na tejto internetovej adrese: www.electrovoice.com
SL	Bosch Security Systems, LLC potrjuje, da je tip radijske opreme EVOLVE70-SB-EU, EVOLVE90-SB-EU, EVOLVE70-SW, EVOLVE90-SW skladen z Direktivo 2014/53/EU. Celotno besedilo izjave EU o skladnosti je na voljo na naslednjem spletnem naslovu: www.electrovoice.com
SV	Härmed försäkrar Bosch Security Systems, LLC att denna typ av radioutrustning EVOLVE70-SB-EU, EVOLVE90-SB-EU, EVOLVE70-SW, EVOLVE90-SW överensstämmer med direktiv 2014/53/EU. Den fullständiga texten till EU-försäkran om överensstämmelse finns på följande webbadress: www.electrovoice.com

12.5.3

Regulatory notice for CE - Information concerning the use of apparatus

This equipment has been tested and found to be compliant with class B emission limits. The electromagnetic disturbance generated does not exceed the level above which radio and telecommunications equipment or other equipment cannot operate as intended. This means that there are no restrictions for usage in residential and commercial environments.

12.5.4

Certifications

Brazil:

Após uma perturbação da rede elétrica, o EVOLVE pode entrar em estado de segurança. Neste caso, você deve desligar e ligar o dispositivo novamente.

Este equipamento não tem direito à proteção contra interferência prejudicial e não pode causar interferência em sistemas devidamente autorizados.

Este equipamento deve ser conectado obrigatoriamente em tomada de rede de energia elétrica que possua aterramento (três pinos), conforme a Norma de instalações elétricas ABNT NBR 5410, visando a segurança dos usuários contra choques elétricos.

Incorpora produto homologado pela ANATEL sob número 01000-24-07826.

Para mais informações, consulte o site da ANATEL: www.anatel.gov.br.

Mexico:

“La operación de este equipo está sujeta a las siguientes dos condiciones: (1) es posible que este equipo o dispositivo no cause interferencia perjudicial y (2) este equipo o dispositivo debe aceptar cualquier interferencia, incluyendo la que pueda causar su operación no deseada”



IFETEL ID: ROELEV25-14393

Republic of Korea:

	<p>기자재명칭: EVOLVE COLUMN LOUDSPEAKER SYSTEM 모델명: EVOLVE70-SB-EU (F.01U.426.433), EVOLVE70-SW (F.01U.426.434), EVOLVE90-SB-EU (F.01U.426.436), EVOLVE90-SW (F.01U.426.437) 식별번호: R-R-KENT-EVOLVE70 상호명(수입업체명): 킨피니티 유한회사 제조자/국: Bosch Security Systems, LLC / 중국 제조년월: 정격: AC 100-240V, 50-60 Hz, 2.1-0.9 A A/S번호: 파나테크 02-702-2844</p>
---	---

해당 무선설비는 운용 중 전파혼신 가능성이 있음
 해당 무선설비는 전파혼신 가능성이 있으므로 인명안전과 관련된 서비스는 할 수 없습니다

Thailand:

เครื่องโทรคมนาคมและอุปกรณ์นี้มีความสอดคล้องตามมาตรฐานหรือข้อกำหนดทางเทคนิคของกสทช.



12.5.5

Notices

Copyright and disclaimer

All rights reserved. No part of this document may be reproduced or transmitted in any form by any means, electronic, mechanical, photocopying, recording, or otherwise, without the prior written permission of the publisher. For information on getting permission for reprints and excerpts, contact Electro-Voice.

All content including specifications, data, and illustrations in this manual are subject to change without prior notice.



Notice!

To report security vulnerability use this link: <https://psirt.bosch.com/report-a-vulnerability/>

Bluetooth®

The Bluetooth® word mark and logos are registered trademarks owned by Bluetooth SIG, Inc. and any use of such marks by Bosch Security Systems, LLC is under license. Other trademarks and trade names are those of their respective owners.

Radio information

This loudspeaker contains intentionally emitting radio waves in the 2.4Ghz frequency band (2,400 MHz to 2483.5 MHz) with a transmit power of 7 dBm +/- 1 dB EIRP. The system uses one antenna with a gain of 1dBi +/- 1dB.

本表系根据SJ/T 11364-2024的规定编制而成 针对在中国境内使用：China RoHS 信息表 扬声器										
产品中有害物质的名称及含有信息表										
部件名称	有害物质									
	Pb 铅	Hg 汞	Cd 镉	Cr(VI) 六价铬	PBB 多溴联苯	PBDE 多溴二苯 醚	DEHP 邻苯二甲 酸二(2-乙 基)己酯	BBP 邻苯二甲 酸丁基苯 酯	DBP 邻苯二甲 酸二正丁 酯	DIBP 邻苯二甲 酸二异丁 酯
金属部件	X	○	○	○	○	○	○	○	○	○
塑胶部件	○	○	○	○	○	○	○	○	○	○
外壳	○	○	○	○	○	○	○	○	○	○
电子元件-LED元件	X	○	○	○	○	○	○	○	○	○
电子元件-印制电路板	X	○	○	○	○	○	○	○	○	○
电缆和电缆配件	○	○	○	○	○	○	○	○	○	○
注 1：○：表示该有害物质在该部件所有均质材料中的含量均不超出电器电子产品有害物质限制使用国家标准要求。 X：表示该有害物质至少在该部件的某一均质材料中的含量超出电器电子产品有害物质限制使用国家标准要求。 注 2：以上未列出的部件，表明其有害物质含量均不超出电器电子产品有害物质限制使用国家标准要求。 关于该类产品生产日期代码的详细说明，请见： http://www.boschsecurity.com/datecodes/										
 本标识内数字表示产品在正常使用状态下的环保使用期限为 10 年										

QA PASS 合格证
博世安防系统

Importers

China

Bosch (Shanghai) Security Systems Ltd.
 333 Fuquan Road North IBP
 Changning District Shanghai
 200335 P.R. China

博世 (上海) 安保系统有限公司
 上海市长宁区虹桥临空经济园区，福泉北路333号

Mexico

Robert Bosch de R.L de C.V.
 Calle Robert Bosch No. Ext. 405
 C.P.50071
 Zona industrial Toluca
 Mexico
 Phone: +52 722 279 2300

Disposal

Old electrical and electronic equipment

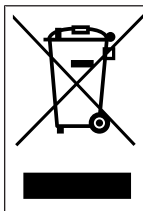

This product and/or battery must be disposed of separately from household waste. Dispose such equipment according to local laws and regulations, to allow their reuse and/or recycling. This will help in conserving resources, and in protecting human health and the environment.

For use in France: Sorting Info label (Info-tri)



More information

For additional regulatory and country-specific certification information, refer to the column loudspeaker system's LCD screens.

To find additional regulatory and country-specific certification information:

1. Navigate to the **IMPRINT & LICENSE** section in the main DSP menu.
2. Press the encoder.
3. Select **License Text**.
4. Press the encoder.
5. Select **Legal pg1**.
6. Press the encoder.
7. Select **Legal pg2**.
8. Press the encoder.
9. Select **EXIT**.

Download the Electro-Voice QuickSmart Mobile app for iOS and Android. Ensure that the loudspeaker's firmware is up to date for the most recent legal and regulatory information.

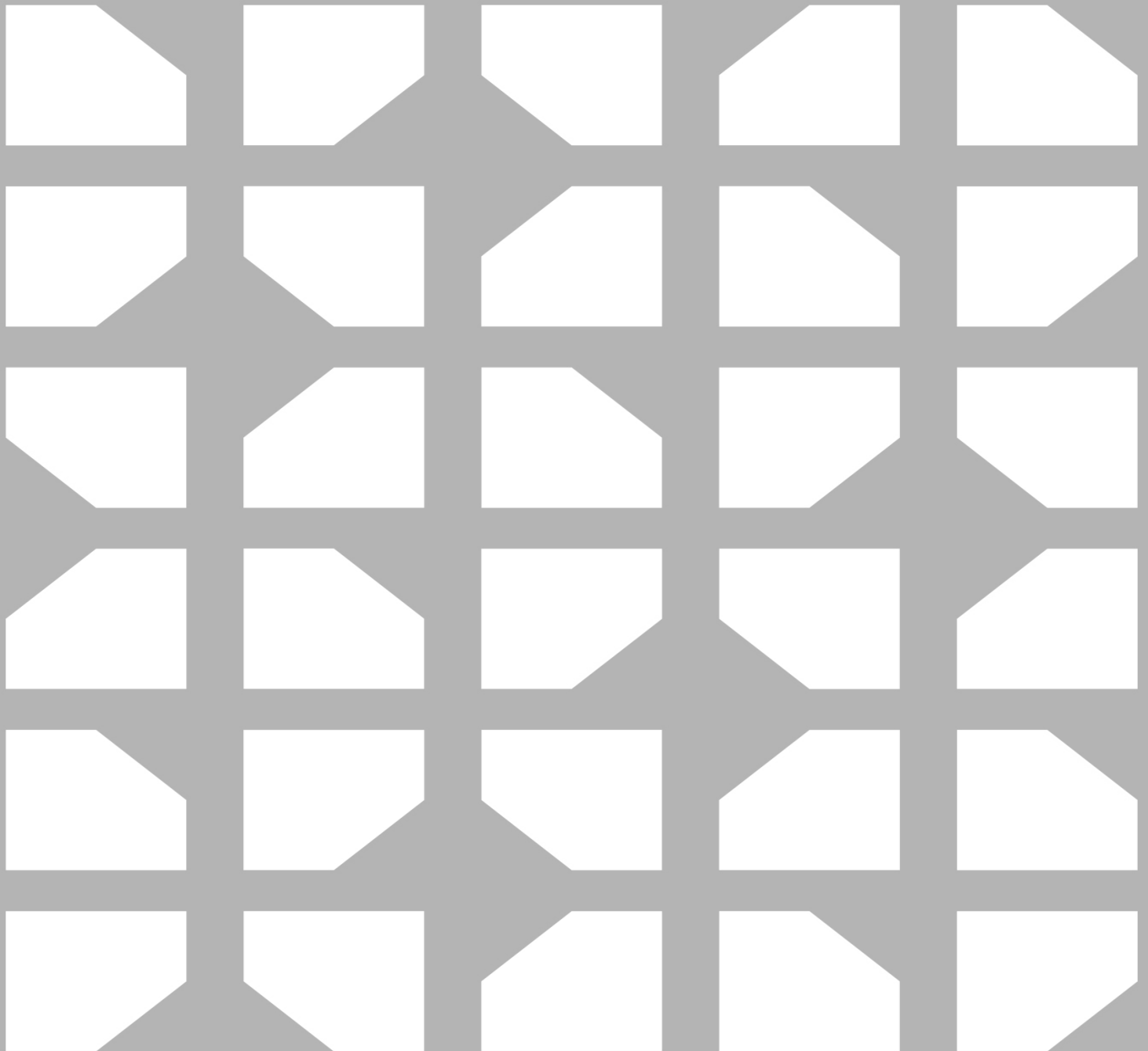

Bosch Security Systems, LLC

130 Perinton Parkway

Fairport, NY 14450

USA

www.electrovoice.com

© Bosch Security Systems, LLC, 2025

EU importer:

EVI Audio GmbH

Sachsenring 60

94315 Straubing

Germany

© EVI Audio GmbH, 2025