

**Electro-Voice** | EVF-1152D/64-FG Premium arrayable point-source 15" fully-weatherized loudspeaker

## EVF-1152D/64-FG Premium arrayable point-source 15" fully-weatherized loudspeaker

- 15-inch arrayable two-way point-source loudspeaker
- Rotatable constant directivity waveguide
- 100 dB sensitivity, 134 dB maximum SPL
- System rating: 600 W continuous, 2400 W peak
- Partially-weatherized PI and fully-weatherized FG versions available with gland nut and stainless-steel grille

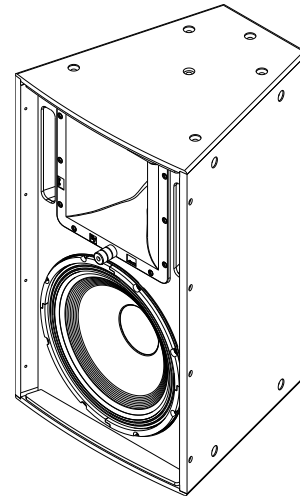

The Electro-Voice EVF-1152D/64-FG is a fully-weatherized, fiberglass-coated, high-power, two-way loudspeaker system that can be used in a variety of applications where high-quality sound reinforcement is required in a compact, lightweight package.

The EVF-1152D/64-FG utilizes the DH7N, a high-output 3" titanium compression driver, coupled to a Constant Directivity 60° x 40° waveguide. The DVX3151A 15" woofer was developed using FEA optimization for motor, suspension, and electrical design to ensure very low distortion, high efficiency, and maximum intelligibility at high SPL. The crossover uses steep, 24-dB-per-octave slopes with equalization for very smooth response in the vocal range, linear off-axis response, and a protection circuit for long-term reliability.

The EVF-1152D/64-FG's features make it ideal for many fixed-install applications, including applications with full exposure to outdoor elements. The trapezoidal enclosure is constructed of weather-resistant birch, and coated with fiberglass for maximum protection from extreme outdoor elements. The unique acoustic and rigging design allows for vertical and horizontal arrays to be built using any combination of loudspeakers from the entire EVF and EVH series. With seven horn patterns to choose from, along with an assortment of low-frequency and subwoofer loudspeakers, you have the tools to maximize flexibility of system design, no matter what the application and budget. The innovative input panel provides a choice of Phoenix-style connector (included in all standard models) or the ability to add a dual NL4-type connector cover plate or gland-nut cover plate (for weatherizing applications). An externally accessible jumper selects passive or active operation.

An available 70.7/100-V transformer kit may be easily mounted to the input panel for use in distributed systems. All these features give you the flexibility to address a large range of venues, quickly and precisely supporting customer requirements with fewer items in inventory.

### Technical specifications

Frequency response (-3 dB): 107 Hz - 18 kHz
Frequency range (-10 dB): 58 Hz - 21 kHz
Rotatable coverage: 60° x 40°
Rec. high-pass frequency: 55 Hz
Passive crossover frequency: 1300 Hz
Axial sensitivity: 100 dB (1 W/1 m)
Max. calculated SPL: 134 dB
Passive power handling: 600 W continuous, 2400 W peak
Impedance: 8 ohms (nominal), 6.0 ohms (min.)
LF transducer - DVX3151A, 15 in (381 mm) driver
LF axial sensitivity: 100 dB (1 W/1 m)
LF max. calculated SPL: 133 dB
LF power handling: 500 W continuous, 2000 W peak
LF impedance: 8 ohms (nominal), 7.2 ohms (min.)
HF transducer - DH7N, 3 in (76 mm) diaphragm compression driver
HF axial sensitivity: 113 dB (1 W/1 m)
HF max. calculated SPL: 138 dB
HF power handling: 75 W continuous, 300 W peak
HF impedance: 8 ohms (nominal), 6.0 ohms (min.)

Connectors: Dual four-pin 10 AWG Phoenix/Euro Block screw-terminals, CDG dual-gland-nut input panel cover included for weatherizing
Enclosure: 13-ply weather-resistant birch with fiberglass finish
Grille: 18 GA stainless steel with hydrophobic cloth
Environmental: IEC 60529 IP55
Suspension: (22) M10 threaded suspension points
Dimensions (H x W x D): 30.26 in x 18.50 in x 18.37 in (768.6 mm x 469.8 mm x 466.6 mm)
Net weight: 75.7 lb (34.4 kg)
Shipping weight: 86.0 lb (39.1 kg)

**Frequency Response & Impedance:**

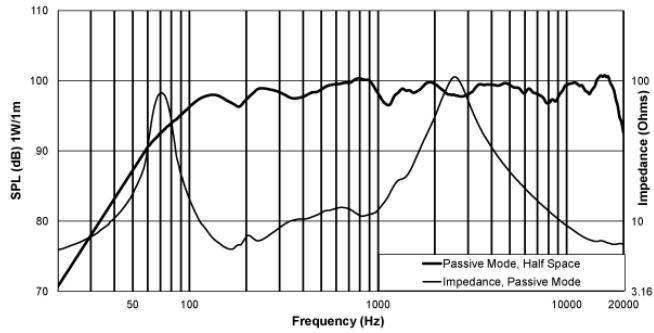

**Horizontal Off Axis Frequency Response:**

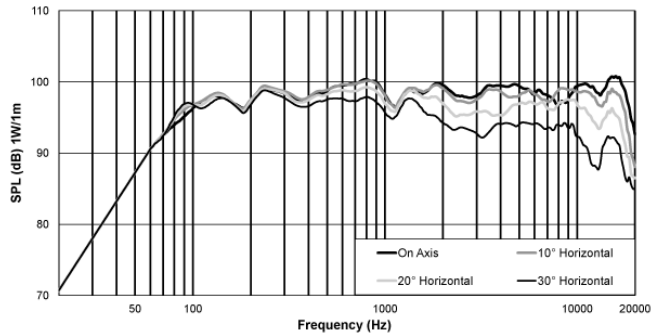

**Vertical Off Axis Frequency Response (Up):**

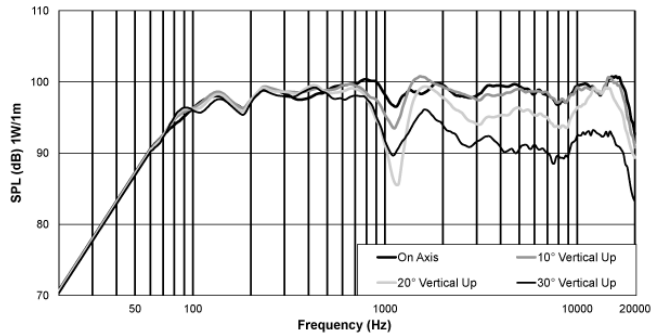

**Vertical Off Axis Frequency Response (Down):**

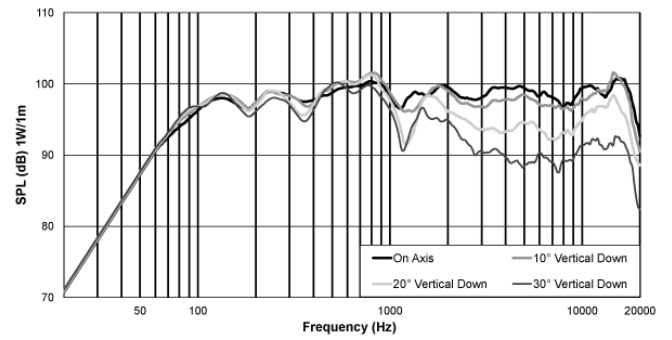

**Beamwidth:**

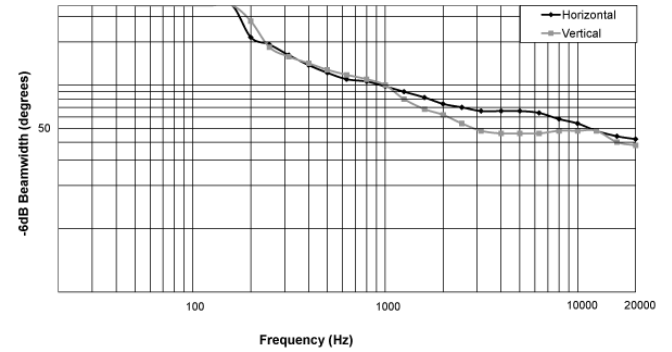

**Directivity:**

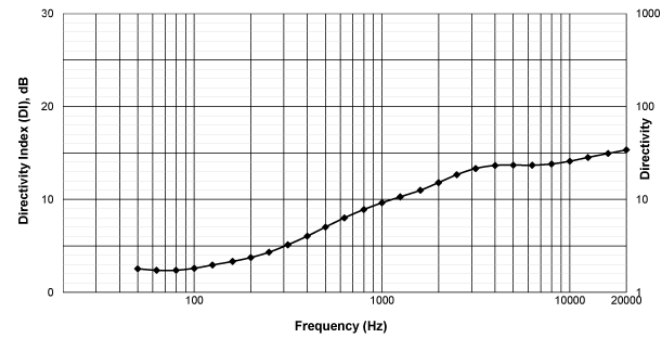

**Block Diagram (Biamp):**

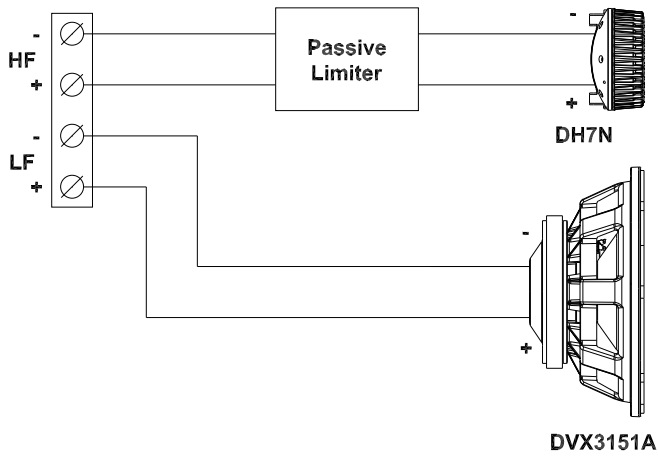

**Block Diagram (Passive):**

Standard shipping configuration

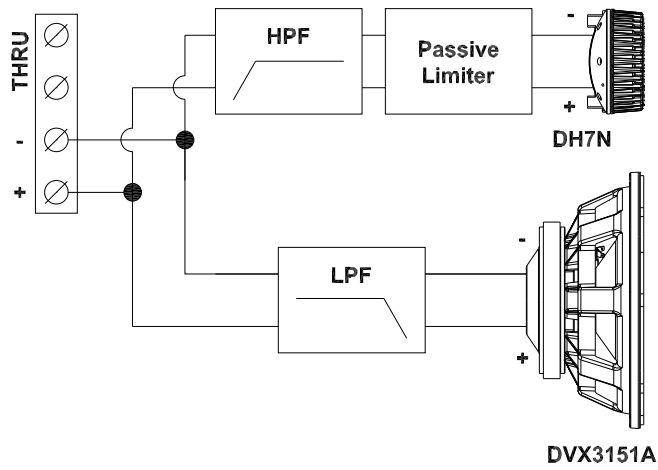

**Polar Plots (1/3 Octave):**

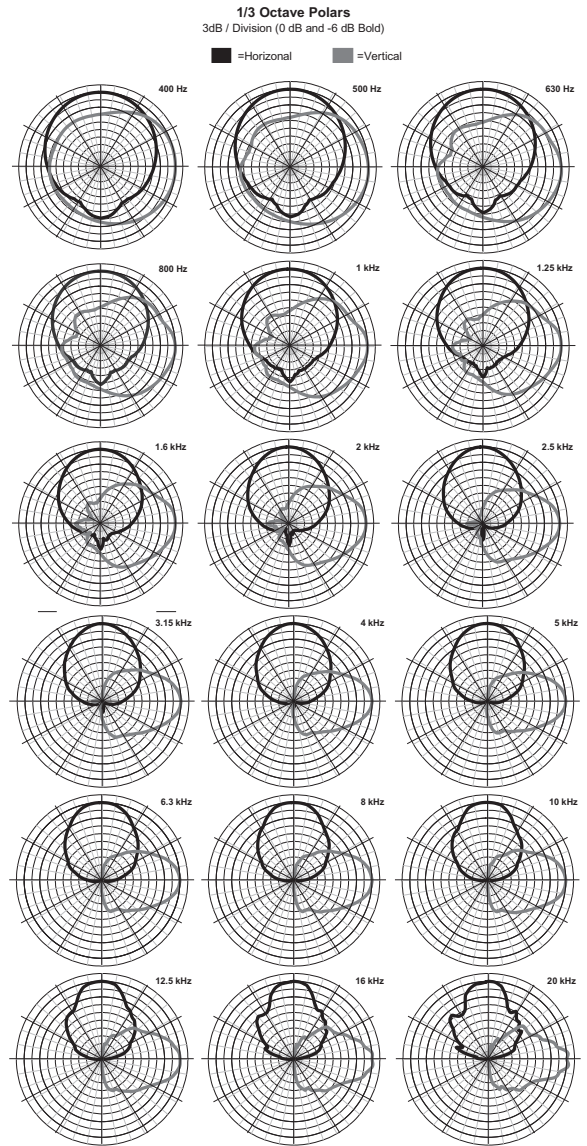

**Dimension Drawing:**

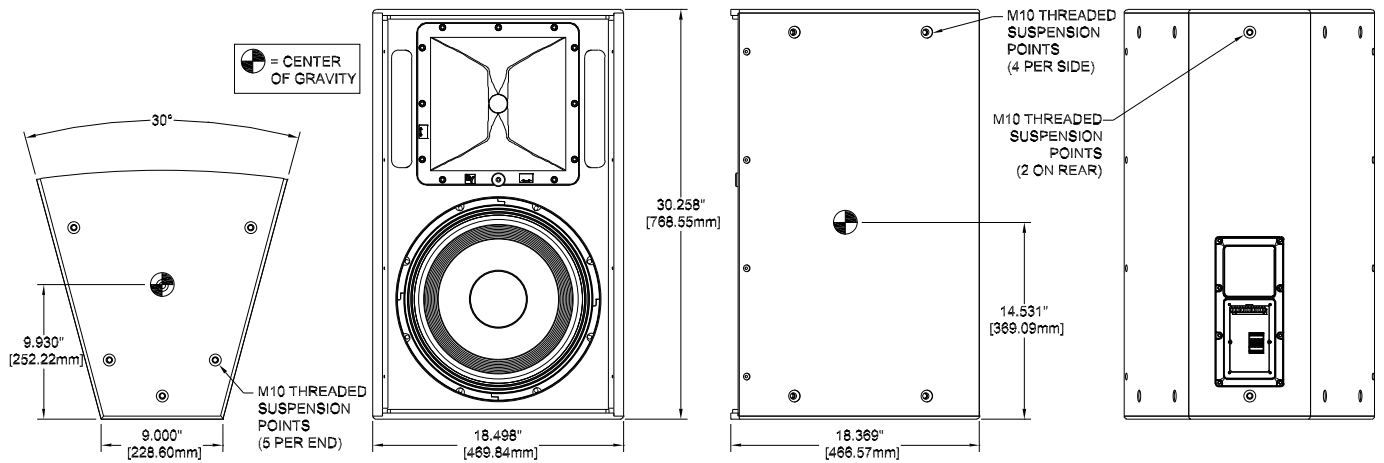

**Notice**

This Electro-Voice loudspeaker should be suspended overhead only in accordance with the procedures and limitations specified in the User's Manual and possible manual update notices. This system should be suspended with certified rigging hardware by an authorized rigging professional and in compliance with local, state, and federal overhead suspension ordinances.

**Compatible System Solutions:**

EVF-1122D/64	60° x 40° Coverage
EVF-1122D/66	60° x 60° Coverage
EVF-1122D/94	90° x 40° Coverage
EVF-1122D/96	90° x 60° Coverage
EVF-1122D/99	90° x 90° Coverage
EVF-1122D/126	120° x 60° Coverage
EVF-1152D/43	40° x 30° Coverage
EVF-1152D/66	60° x 60° Coverage
EVF-1152D/94	90° x 40° Coverage
EVF-1152D/96	90° x 60° Coverage
EVF-1152D/99	90° x 90° Coverage
EVF-2121S	Dual 12" Bass Element
EVF-2151D	Dual 15" Bass Element
CPS2.9	120V Power Amplifier, 2 x 900W
CPS2.12	120V Power Amplifier, 2 x 1200W
CPS4.5	120V Power Amplifier, 4 x 500W
CPS4.10	120V Power Amplifier, 4 x 1000W

**Ordering information**

**EVF1152D64BLB 15" speaker 60x40 indoor black**  
 EVF 15" / 2-way Full-range Systems; DVX woofer & DH7N driver (600 W cont.); 60° x 40°, EVCoat, black  
 Order number **EVF1152D64BLB | F.01U.272.566**

**EVF1152D64WLB 15" speaker 60x40 indoor white**  
 EVF 15" / 2-way Full-range Systems; DVX woofer & DH7N driver (600 W cont.); 60° x 40°, EVCoat, white  
 Order number **EVF1152D64WLB | F.01U.272.567**

**EVF1152D64PBLB 15" speaker 60x40 weatherized black**  
 EVF 15" / 2-way Full-range Systems; DVX woofer & DH7N driver (600 W cont.); 60° x 40°, EVCoat, PI-weatherized, black  
 Order number **EVF1152D64PBLB | F.01U.272.568**

**EVF1152D64PWL 15" speaker 60x40 weatherized white**  
 EVF 15" / 2-way Full-range Systems; DVX woofer & DH7N driver (600 W cont.); 60° x 40°, EVCoat, PI-weatherized, white  
 Order number **EVF1152D64PWL | F.01U.272.569**

**EVF1152D64FBLB 15" speaker 60x40 fiberglass black**  
 EVF 15" / 2-way Full-range Systems; DVX woofer & DH7N driver (600 W cont.); 60° x 40°, EVCoat, fiberglass, black  
 Order number **EVF1152D64FBLB | F.01U.272.951**

**EVF1152D64FWLB 15" speaker 60x40 fiberglass white**  
 EVF 15" / 2-way Full-range Systems; DVX woofer & DH7N driver (600 W cont.); 60° x 40°, EVCoat, fiberglass, white  
 Order number **EVF1152D64FWLB | F.01U.272.952**

**Accessories**

**CDNL4-LB Input panel cover plate, dual NL4 type**  
 Dual NL4 cover kit for EVA, EVC, EVF & EVH, black  
 Order number **CDNL4-LB | F.01U.283.495**

**CSG-LB Input panel cover plate single gland nut**  
 Single gland nut cover kit for EVA, EVC, EVF & EVH, black  
 Order number **CSG-LB | F.01U.283.496**

**CDG-LB Input panel cover plate, dual gland nut**  
 Dual gland nut cover kit for EVA, EVC, EVF & EVH  
 Order number **CDG-LB | F.01U.283.497**

**TK-150 70/100 Volt transformer kit**  
 Transformer kit for EVC, EVF, and EVH, 150W/70V  
 Order number **TK-150 | F.01U.132.318**

**HRK-1B-LB Horizontal rigging kit black, EVF + EVF**  
 Horizontal rigging kit for EVF, black  
 Order number **HRK-1B-LB | F.01U.283.502**

**HRK-1W-LB Horizontal rigging kit white, EVF + EVF**  
 Horizontal rigging kit for EVF, white  
 Order number **HRK-1W-LB | F.01U.283.503**

**HRK-2B-LB Horizontal rigging kit black, EVF + EVH**

Horizontal rigging kit for EVF & EVH full-range to EVF sub, black

Order number **HRK-2B-LB | F.01U.283.504**

---

**HRK-2W-LB Horizontal rigging kit white, EVF + EVH**

Horizontal rigging kit for EVF & EVH full-range to EVF sub, white

Order number **HRK-2W-LB | F.01U.283.505**

---

**VRK-1B-LB Vertical rigging kit black, EVF + EVF**

Vertical rigging kit for EVF, black

Order number **VRK-1B-LB | F.01U.283.506**

---

**VRK-1W-LB Vertical rigging kit white, EVF + EVF**

Vertical rigging kit for EVF, white

Order number **VRK-1W-LB | F.01U.283.507**

---

**VRK-2B-LB Vertical rigging kit black, EVF + EVH**

Vertical rigging kit for EVF & EVH full-range to EVF subs, black

Order number **VRK-2B-LB | F.01U.283.508**

---

**VRK-2W-LB Vertical rigging kit white, EVF + EVH**

Vertical rigging kit for EVF & EVH full-range to EVF subs, white

Order number **VRK-2W-LB | F.01U.283.509**

---

**EVF-UB-BLK-LB U-bracket for all EVF speakers black**

Mounting bracket for EVF, black

Order number **EVF-UB-BLK-LB | F.01U.283.510**

---

**EVF-UB-WHT-LB U-bracket for all EVF speakers white**

Mounting bracket for EVF, white

Order number **EVF-UB-WHT-LB | F.01U.283.511**

---

**Represented by:**

**Germany:**  
Bosch Sicherheitssysteme GmbH  
Robert-Bosch-Ring 5  
85630 Grasbrunn  
Germany  
www.electrovoice.com

Bosch Security Systems, LLC  
12000 Portland Avenue South  
Burnsville MN 55337  
USA