

MTS-4153-64FWW Loudspeaker high output 60x40 FW wht

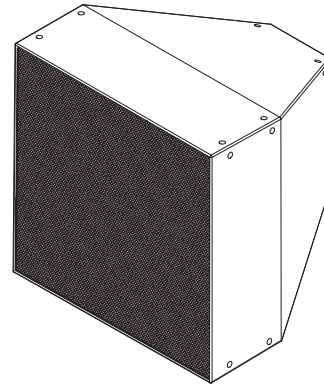

Electro-Voice

- Full-range, high-output, horn-loaded loudspeaker with exact directivity for very long throw applications
- Lossless Hydra™ waveform converter couples dual coaxial compression drivers to a constant directivity (CD) waveguide with pattern control to below 350 Hz
- Four woofers couple to the same waveguide, creating a true point source with substantial bass response
- Optimized acoustic design, amplifier matching, and DSP to ensure perfectly controlled SPL and coverage, even at full output



The MTS-4153-64FWW is a full-range, high-output, point-source loudspeaker with exact directivity for very-long-throw applications.

MTS is the product of a holistic system approach. Acoustic design, amplifier matching, and digital processing are optimized with proprietary software to ensure precisely distributed SPL that is balanced and controlled throughout the entire coverage area, even at full output. Four slot-loaded, 15-inch high efficiency low-frequency drivers are coupled to the same full-range constant directivity waveguide as two coaxial mid/high frequency compression drivers. This creates a true point-source with substantial bass response, eliminating the need for subwoofers in many applications.

The three-way MTS-4153-43FWW has a 60° x 40° coverage pattern.

The loudspeaker can deliver 151 dB peak (music, with low-frequency response that extends to 55 Hz at -10 dB) and 154 dB peak (speech).

The speaker is typically configured in biamp mode with two low-frequency inputs driven as a single 4 Ω load. The installer could also drive the low-frequency inputs separately using two cable runs to minimize signal losses over long distances.

The loudspeaker is designed for outdoor use with full exposure to the elements.

All MTS loudspeakers have an IP55 rating, indicating that they are impervious to dust and water ingress. MTS is engineered for use with Dynacord IPX series amplifiers. Proprietary speaker settings and limiter functions ensure exceptional performance with long-

term reliability at extremely high output levels. A package of design files is provided for advanced system simulation in venues. Electro-Voice PREVIEW Loudspeaker Software is the fastest and most accurate way to create acoustic designs with MTS.

Parts included

Quantity	Component
1	Full-range horn-loaded speaker
1	Gland nut cover
1	Installation manual
1	Warranty card

Technical specifications

Frequency response (-3 dB) ¹ :	62 Hz - 18 kHz
Frequency range (-10 dB) ¹ :	55 Hz - 20 kHz
Max. SPL (music) ² :	151 dB
Max. SPL (speech) ³ :	154 dB
Coverage (H x V):	60° x 40°
Input connections:	LF1, LF2, MHF
Minimum required amplifier channels (LF1 + LF2 wired parallel):	2
LF1 maximum input power (20 ms avg) ⁴ :	1250 W
LF1 maximum peak input voltage ⁵ :	150 V
LF1 nominal input impedance:	8 Ω
LF2 maximum input power (20 ms avg) ⁴ :	1250 W
LF2 maximum peak input voltage ⁵ :	150 V
LF2 nominal input impedance:	8 Ω
MHF maximum input power (20 ms avg) ⁴ :	1250 W
MHF maximum peak input voltage ⁵ :	140 V
MHF nominal input impedance:	6 Ω
Connectors:	10 AWG (6 mm ²) Phoenix/Euroblock input and pass through
Enclosure:	Weather resistant birch plywood with EVCoat
Grille:	16 gauge stainless steel with hydrophobic screen
Suspension:	(24) M10 hard points
Color:	RAL 9003 White
Dimensions (H x W x D):	1092 mm x 1092 mm x 1096 mm (43.0 in x 43.0 in x 43.1 in)
Net weight:	160 kg (353 lbs)
Shipping weight:	208 kg (458 lbs)
Weatherization:	FW: outdoor full exposure
Ingress Protection (IP) rating:	55

¹Full space with MTS full range preset.

²Peak SPL measured full space at 4 m and referenced to 1 m. 12 dB crest factor broadband pink noise.

³Peak SPL measured full space at 4 m and referenced to 1 m. 12 dB crest factor 100-5k Hz pink noise.

⁴Required amplifier power for maximum output.

⁵Electro-Voice 500 hour accelerated life test.

Frequency response

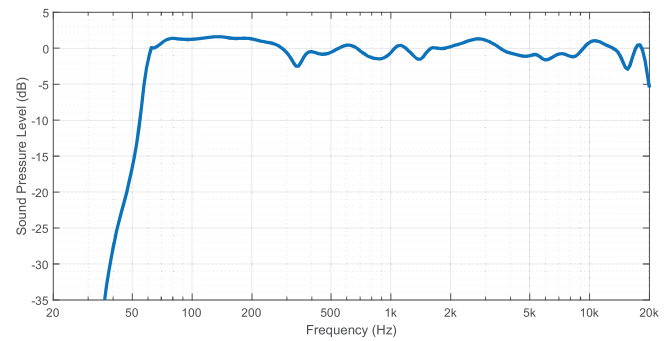

Impedance response

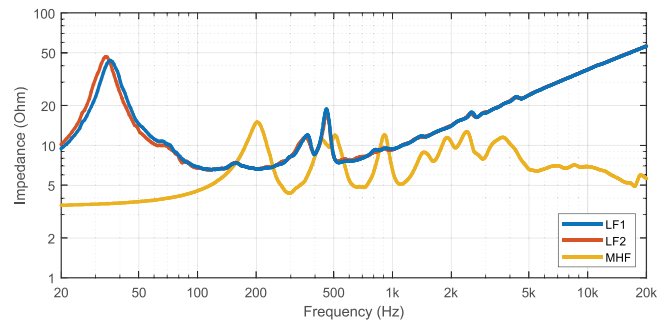

Beamwidth

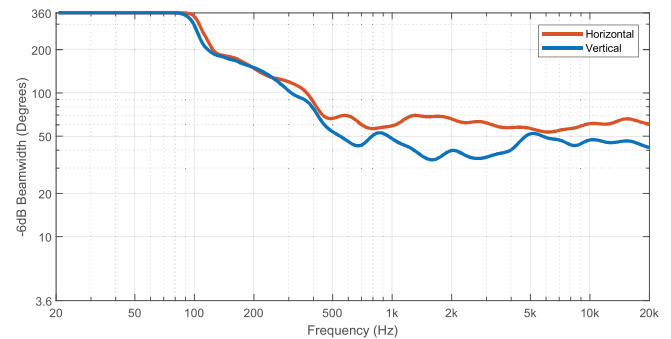

Horizontal spatial frequency response

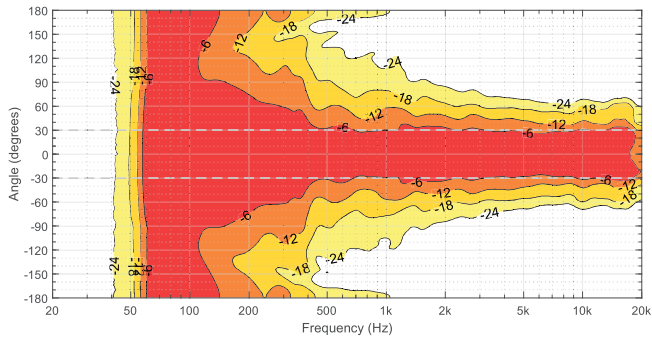

Vertical spatial frequency response

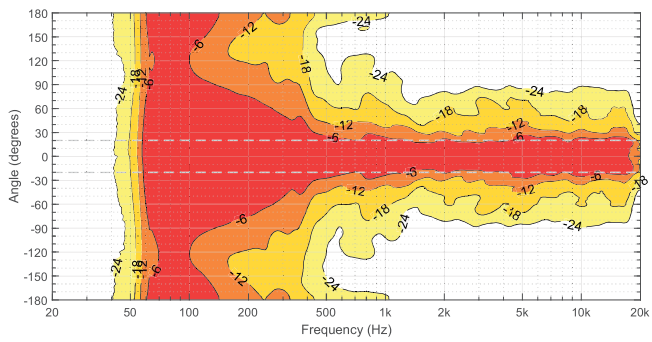

Dimensions

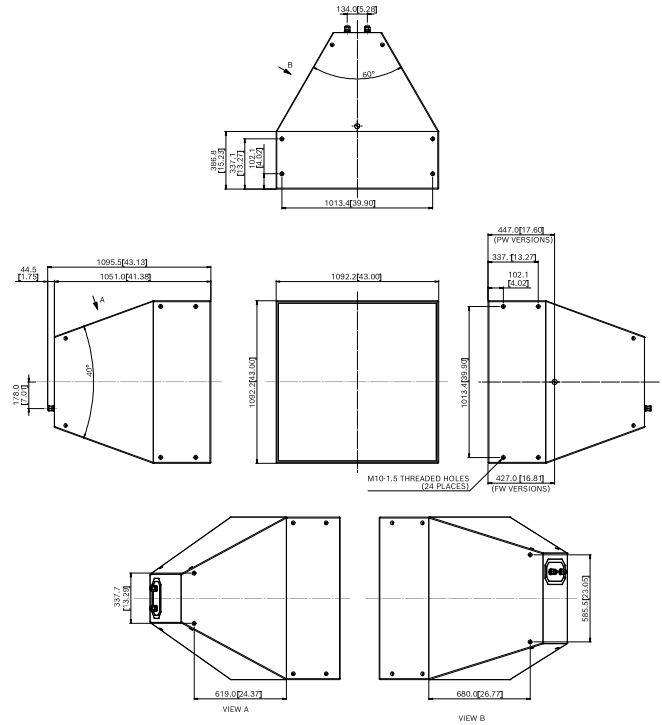

Amplifier configurations

Amplifier	IPX 20:4	IPX 10:4	IPX 5:4	
Total no. of speakers	2	4	2	1
Channel				
1	LF1 LF2 (1 box)	LF1 LF2 (2 boxes)	LF1 LF2 (1 box)	LF1 (1 box)
2	MHF (1 box)	MHF (2 boxes)	MHF (1 box)	LF2 (1 box)
3	LF1 LF2 (1 box)	LF1 LF2 (2 boxes)	LF1 LF2 (1 box)	MHF (1 box)
4	MHF (1 box)	MHF (2 boxes)	MHF (1 box)	(available)
Monitoring and processing	Per Box	Per Pair	Per Box	Per Box
Worst case Max SPL reduction (dB)	0 (3 dB Headroom)	-0.8	0	0

Architectural and engineering specifications

The loudspeaker system shall be a three-way, bi-amplified design with dual Phoenix-type input connectors, wherein connector terminals 1 +/- and 2 +/- are wired to two separate pairs of 15-inch low-frequency transducers, terminals 3 +/- are wired to a passive crossover that feeds two mid/high-frequency coaxial compression drivers, and terminals 4 +/- are wired as a pass thru between the two input connectors. The mid-high-frequency ring radiator coaxial drivers shall be coupled to a 60° x 40° constant directivity arc-source horn through a low-loss waveform converter. Each mid/high-frequency compression driver shall be constructed with concentric voice coils: a 100 mm voice coil driving an annular diaphragm for midrange frequencies and a 65 mm voice coil driving a separate annular diaphragm for high frequencies. The mid/high-frequency coaxial compression drivers shall be wired in parallel and driven through a passive network with a crossover point of 3.6 kHz, presenting a nominal 6 Ohm load. The maximum peak input voltage and maximum input power to the mid/high frequency section shall be 140 volts and 1250 Watts, respectively. The 15-inch low-frequency drivers shall all be constructed with 3-inch voice coils and shall be slot-loaded and co-entrant on the same arc-source horn. Each pair of low-frequency transducers shall be wired in parallel for a nominal 8 Ohm load. The maximum peak input voltage and maximum input power to each of the low-frequency pairs shall be 150 volts and 1250 Watts.

The trapezoidal cabinet angles shall be 60° in the horizontal aspect and 40° vertical aspect, mirroring the loudspeaker's acoustic coverage pattern. The loudspeaker system shall have a protective EVCoat white finish applied to completely seal the cabinet interior and exterior, making it suitable for installation in locations with full exposure to the elements. The grille shall be constructed using 16 gauge perforated stainless steel and shall be assembled with a hydrophobic screen backing. The loudspeaker shall have an ingress protection rating of IP55 when installed at a minimum 5° down angle. The loudspeaker system shall include a moisture-proof gland nut cover that accepts cable diameters between 9 mm (0.35 in.) and 19 mm (0.74 in.).

When driven by the manufacturer's recommended amplification and signal processing, the system shall be capable of producing 151 dB peak SPL output for an input signal comprising full-range pink noise with a 12 dB crest factor. The loudspeaker's -3 dB bandwidth corner frequencies shall be 62 Hz and 18 kHz; the end points for -10 dB bandwidth shall be 55 Hz and

20 kHz. For a 12 dB crest factor pink noise input that has been band limited from 100 Hz to 5 kHz, the maximum peak SPL output shall be 154 dB. The system shall employ 24 M10 hard points for attachment to cable support systems or structural framing. Net weight shall be 160 kg (353 lbs.). The loudspeaker dimensions shall be 1092 mm (43.0 in.) high by 1092 mm (43.0 in.) wide by 1096 mm (43.1 in.) deep. The loudspeaker shall be the MTS-4153-64FWW from Electro-Voice.

Complementary products

MTS-4153-43FWW Loudspeaker high output 40x30 FW wht

MTS-6154-43CFWW Loudspeaker cardioid 40x30 FW wht

MTS-6154-64CFWW Loudspeaker cardioid 60x40 FW wht

Compatible system solutions

X12I-128-FGW 2x18" Install sub white FG

Compatible system solutions, electronics

Dynacord IPX10:4 DSP power amplifier 4x2500W, install

Dynacord IPX20:4 DSP power amplifier 4x5000W, install

Dynacord IPX10:8 DSP power amplifier 8x1250W, install

Dynacord IPX5:4 DSP power amplifier 4x1250W, install

Compatible system solutions, software

Dynacord SONICUE control software

Electro-Voice PREVIEW Loudspeaker software

Ordering information

MTS-4153-64FWW Loudspeaker high output 60x40 FW wht

Full-range, point-source, three-way loudspeaker with 60° x 40° coverage, fully weatherized, white

Order number **MTS-4153-64FWW | F.01U.386.407**

Represented by:

Germany:
Bosch Sicherheitssysteme GmbH
Robert-Bosch-Ring 5
85630 Grasbrunn
Germany
www.electrovoice.com

Bosch Security Systems, LLC
12000 Portland Avenue South
Burnsville MN 55337
USA