

Product registration



Register your EVERSE: electrovoice.com/register

Quick setup

To set up the loudspeaker:

Step	Illustration
1. Connect the AC power cord from a grounded receptacle to the MAINS IN to ensure the battery has sufficient charge. Note: It is recommended to leave the loudspeaker plugged in and charging for 24 hours the first time it is used.	
2. Switch power to ON .	
3. Adjust the volume (VOL) to 0 dB using the MASTER VOL knob.	
4. Push the input selection soft key for INPUT 1 or INPUT 2 if using an XLR or 1/4-inch (6.35 mm) cable, or push the input selection soft key for INPUT 3/4 if using Bluetooth or 3.5 mm mini jack. Use the MASTER VOL knob to adjust INPUT LEVEL to MUTE .	

5. Connect an audio source using an XLR, TRS, or TS cable to **INPUT 1**, **INPUT 2**, or a 3.5 mm mini jack to **INPUT 3/4**. Ensure audio source is **MUTE** or at a low level before making connection. After connection is made, increase the source's output to a reasonable level.

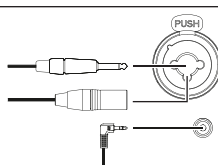

6. Adjust the **INPUT LEVEL** until the signal peaks are just below maximum level or the required output is achieved. If **PK** (PEAK) is indicated, turn the level down until the **PK** indication disappears. Press the input selection soft key again to exit the channel menu.

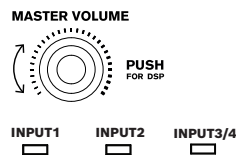

7. Using the **MASTER VOL** knob, adjust the volume (**VOL**) until you get the required output from the loudspeaker.

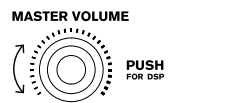

Pairing the QuickSmart Mobile app

The EV QuickSmart Mobile app for tablets and smartphones is available for download from the Apple App Store and the Google Play Store.

Download and check the app for the latest ELX200 firmware updates to enjoy optimal audio performance and maximize your control of the system.



Notice!

The EV QuickSmart Mobile app is designed to only find loudspeakers from Electro-Voice featuring Bluetooth® control functionality. The EV QuickSmart Mobile app will not display other types of Bluetooth® devices, e.g. phones, laptops, tablets, or headsets.

Prior to pairing the EV QuickSmart Mobile app with Electro-Voice loudspeakers:

1. Ensure that Bluetooth® is enabled on the smartphone or tablet.
2. Ensure that pairing mode is enabled on the loudspeaker.

To place the loudspeaker in pairing mode for both control and streaming:

1. Press and hold **INPUT 3/4** until **Pairing Mode On** and the 4-digit ID is shown on the LCD. Pairing mode can be enabled through the LCD menu for control and streaming separately.

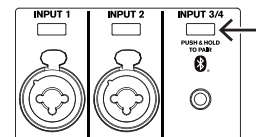

2. Navigate to your mobile device's Bluetooth® settings menu, find the EVERSE loudspeaker with the matching 4-digit ID and ensure you are paired to the loudspeaker. This will pair the mobile device to the EVERSE loudspeaker for audio streaming.
3. Continue to the next step to pair for control.

Notice!



For Android devices ensure location services are allowed. Electro-Voice does not collect, store, or track user location data or personal information.

First time pairing

1. Open the EV QuickSmart Mobile app.
2. **Select your Speakers** is displayed on the screen. The EV QuickSmart Mobile app is looking for available Bluetooth® enabled Electro-Voice loudspeakers. The available loudspeakers are displayed on the screen.
3. Tap the loudspeaker you want to pair with the app. The selected loudspeaker will have a line under it acknowledging it is selected.
4. Repeat the previous step until all of the required loudspeakers are selected.
5. Tap the **CONNECT** button.

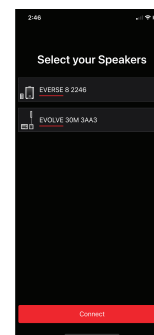
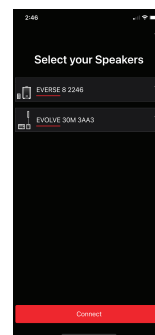

6. The app connects with the selected loudspeaker. You will get a message from iOS/iPadOS/Android about pairing for each device which has to be accepted.
7. Tap **PAIR** on the device to accept pairing to the loudspeakers. The app can connect to up to six loudspeakers.

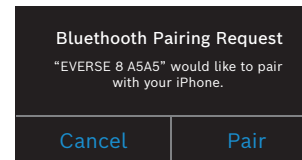

Subsequent pairing

To pair additional loudspeakers with the EV QuickSmart Mobile app:

1. Tap the EV QuickSmart Mobile app icon.
2. **Select your Speakers** is displayed on the screen. The EV QuickSmart Mobile app is looking for available Bluetooth® enabled Electro-Voice loudspeakers. The available loudspeakers are displayed on the screen.
3. Tap the loudspeaker you want to pair with the app. The selected loudspeaker will have a line under it acknowledging it is selected.
4. Repeat the previous step until all of the required loudspeakers are selected.
5. Tap the **CONNECT** button. The app connects with the required loudspeaker. The app can connect to up to six loudspeakers.

Tripod or pole mount

EVERSE loudspeakers mount on a tripod stand or on a pole above a subwoofer.

Mounting a loudspeaker on a tripod stand



Caution!

Tripod is not evaluated for safety with this loudspeaker. Check the specifications of the tripod stand to be certain it is capable of supporting the weight of the loudspeaker.

To mount a loudspeaker on a tripod stand:

1. Place the tripod stand on a level and stable surface.
 - Fully extend the legs on the tripod stand.
 - Do not compromise the tripod stand's structural integrity by trying to make the stand taller.

- Do not attempt to mount more than one loudspeaker on a stand designed for a single loudspeaker.
- Lift the loudspeaker using two hands.
 - Set the pole cup located on the bottom of the loudspeaker onto the pole.
 - Set the loudspeaker location to **TRIPOD** in the DSP control menu.

Mounting a loudspeaker on a pole

To mount a loudspeaker on a pole:

- Place the subwoofer on a level and stable surface.
- Insert the M20 threaded pole into the combo pole cup on the top of the subwoofer.
- Turn the M20 threaded pole clockwise to secure the pole to the subwoofer.

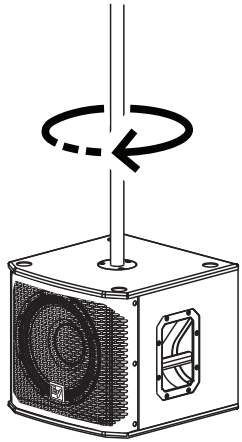

- Lift the loudspeaker using two hands.
- Set the pole cup located on the bottom of the loudspeaker onto the pole.
- Set the loudspeaker location to **TRIPOD** in the DSP control menu.
- Select the corresponding **SUB (X-OVER)** setting for your subwoofer.



Notice!

Select **LOCATION TRIPOD** in menu or app for best sound.

Weatherization

The EVERSE loudspeaker with weatherized input cover installed is intended only for temporary use in wet or damp environments.

- ▶ Use the weatherized input cover when on battery power and when using Bluetooth® streaming and control.

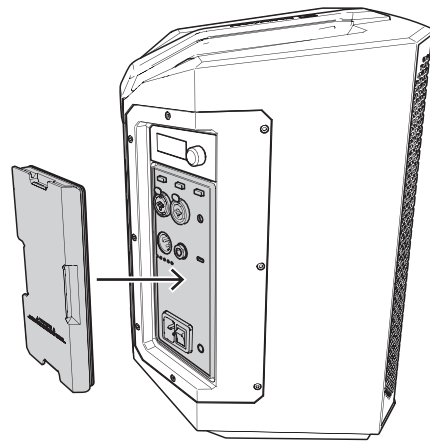

- ▶ Remove the weatherized input cover by pulling the cover carefully and evenly using the finger pull-tabs.

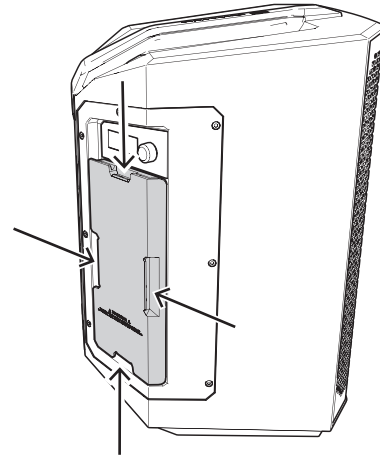

- ▶ Use the Electro-Voice approved accessory raincover (not included) when on mains power, or when any of the I/O connectors are needed.

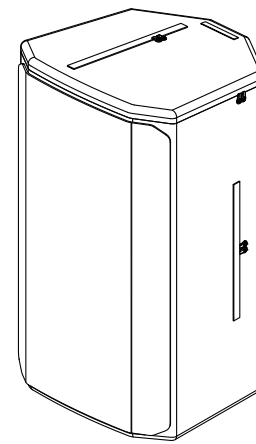

When using EVERSE loudspeakers in damp or wet environments:

- Always consult the user manual for complete instructions.
- Only use Electro-Voice approved accessories.
- DO NOT place the loudspeaker in a puddle or standing water.
- DO NOT place or transport the loudspeaker upside down, or on the amp panel side.
- DO NOT remove the weatherized input cover or battery pack while wet. Let the speaker dry completely before removing.
- DO NOT attempt to use the loudspeaker in damp or wet environments without the battery installed.

Warranty information

For information on warranty periods and after sales service, please visit: www.electrovoice.com/warranty

Battery-powered loudspeaker

EVERSE 8, EVERSE 12

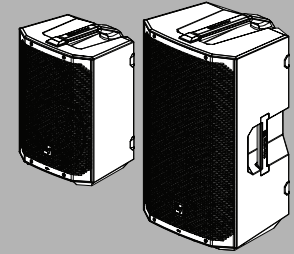

en Quick user guide



Bosch Security Systems, LLC

130 Perinton Parkway
Fairport, NY 14450
USA

www.electrovoice.com

© Bosch Security Systems, LLC, 2024

EU importer:

Bosch Sicherheitssysteme GmbH

Robert-Bosch-Platz 1
70839 Gerlingen
Germany

© Bosch Sicherheitssysteme GmbH,
2024

